





GREENHOUSE

3x6m

Parts		Quantity
Tube No.1		14
Tube No.2		7
Tube No.3		14
Tube No.4		6
Tube No.5		30
Tube No.6		4
Tube No.7		4
Tube No.8		2
Screw		42

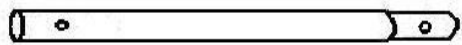
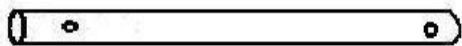
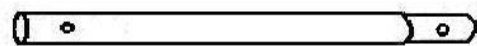
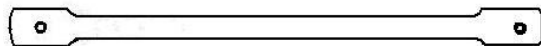
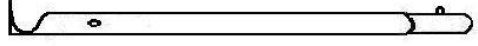
Set up greenhouse as below illustration

Warning: We are not able to be held responsible for any damage to this product caused by wind or bad weather conditions

Mont the tunnel as below plan

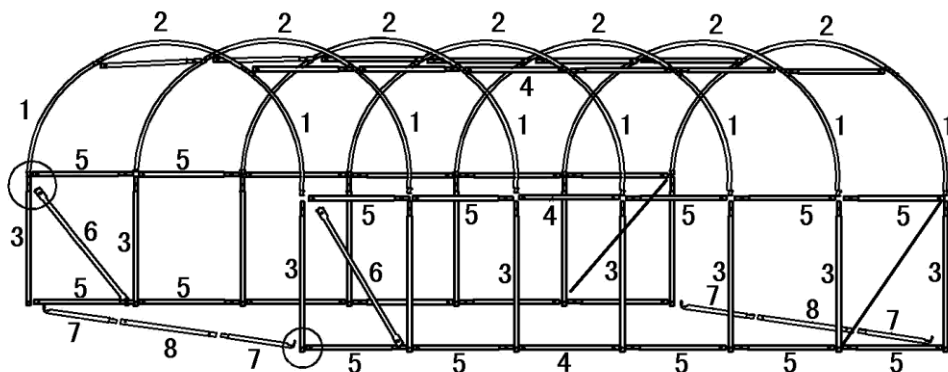

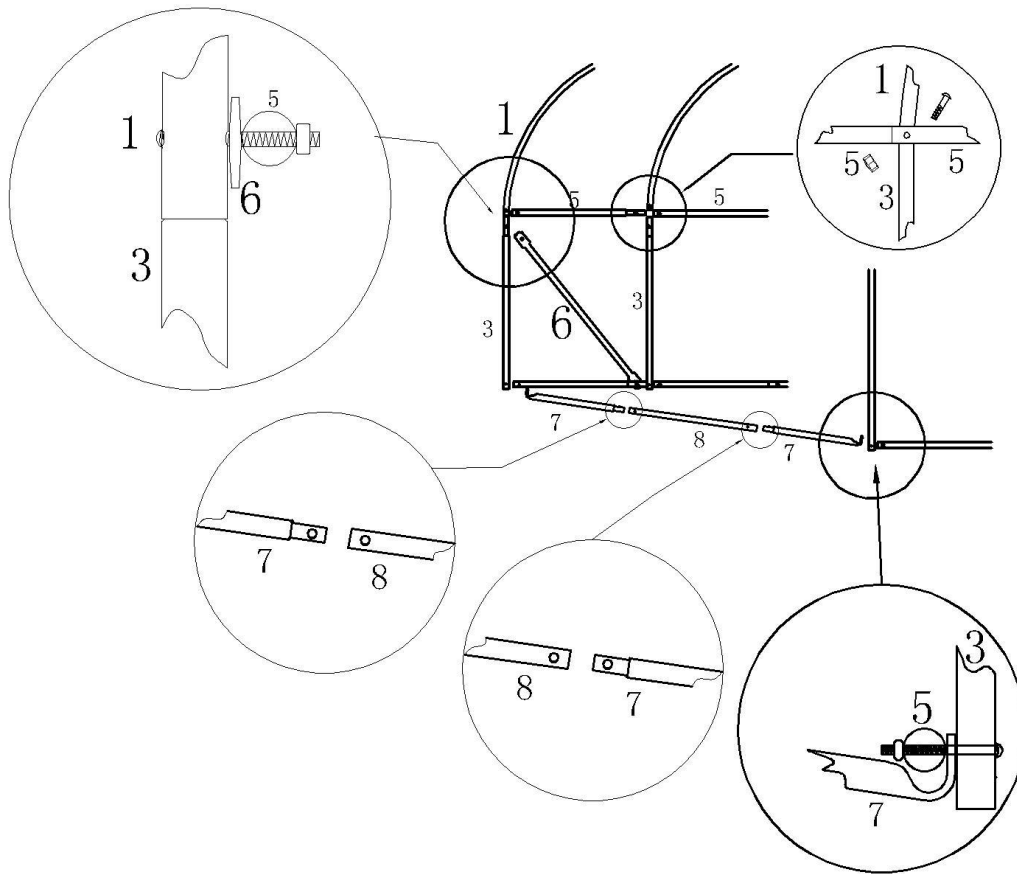

Important

Collect the earth around the frame, later need those earth to cover the skirt on the ground. Put sticks around the lower upright tubes(touching the ground) and connect it with extra rope or tape to the frame(which provide extra strength). So protect your conservatory against strong winds. Provide extra strength by tape around the connecting elements to paste. Place the film on the frame. Use Velcro to fasten the foil to the frame.

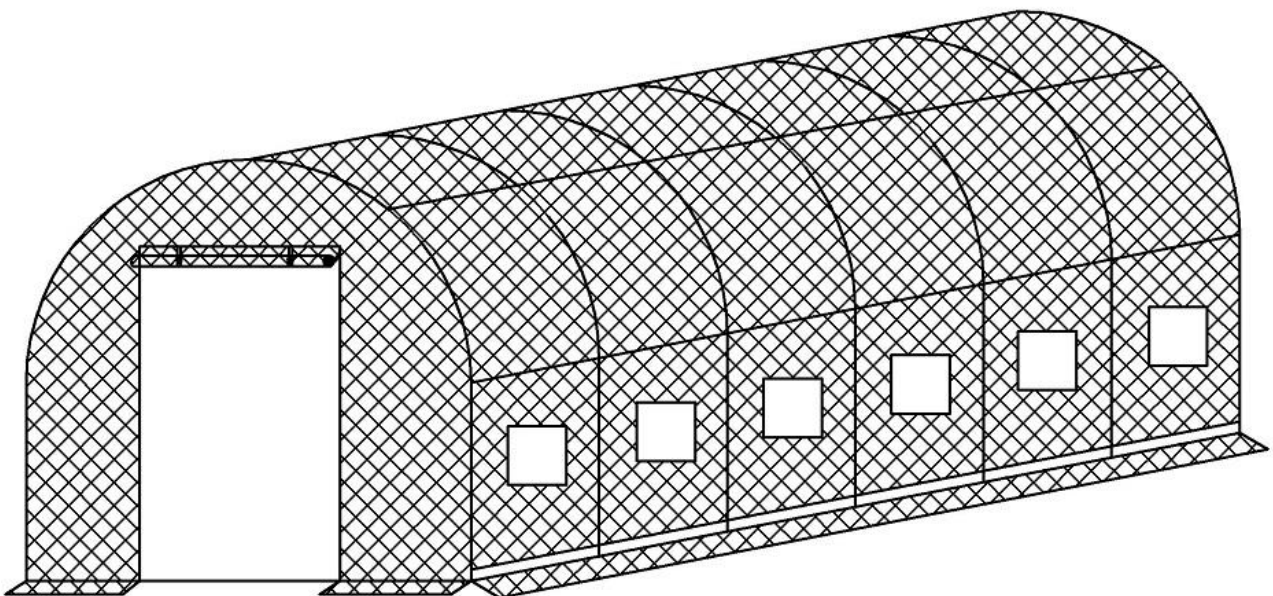

Important:

Cover the overhanging skirt touches the ground with earth, avoid throwing earth near the zippers.

Pls remove the cover away from the frame in winter time, this could last longer life of cover.

