

5X10M PVC PART LIST

(1) 1218mm Galvanized Pipe

Quantity 24



(2) 1940mm Galvanized Pipe

Quantity 35



(3) 1920mm Galvanized Pipe

Quantity 12

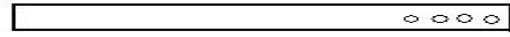

(4) 1275mm Galvanized Pipe

Quantity 12

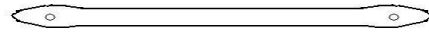

(5) 470 Galvanized Pipe

Quantity 6

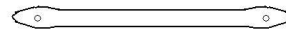

(6) 110° 3 Way joint

Quantity 4



(7) 110° 4Way joints

Quantity 8

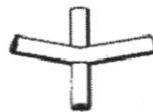

(8) 140° 3 Way joints

Quantity 2



(9) 140° 4 Way joints

Quantity 4

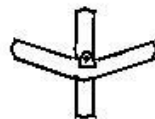

(10) Cross 4 Way joints

Quantity 8

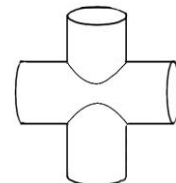

(11) 3 Way joints

Quantity 4

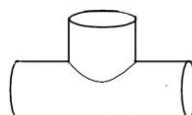

(12) NO.12 3 Way joints

Quantity 4

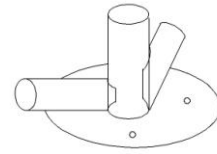

(13) NO.13 3 Way joints

Quantity 8

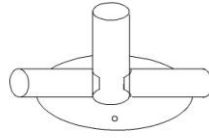

(14) NO.14 3 Way joints

Quantity 4

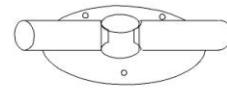

(15) No.15 Ground bar

Quantity 6



Top Cover

Quantity 1

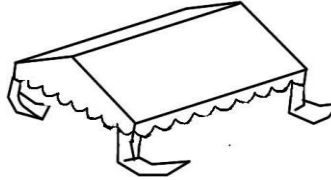

Side Panels

Quantity 10

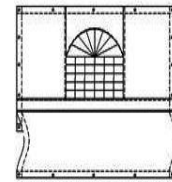

Door Panels

Quantity 2

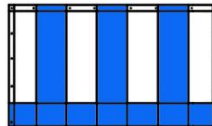

5X10M STRUCTURE TENT

INSTRUCTION

FRAME ASSEMBLY

1. Place all joints, No.1 pipes and No.2 pipes on the ground as shown. Push two pipes into the joints, use screws to fix them.

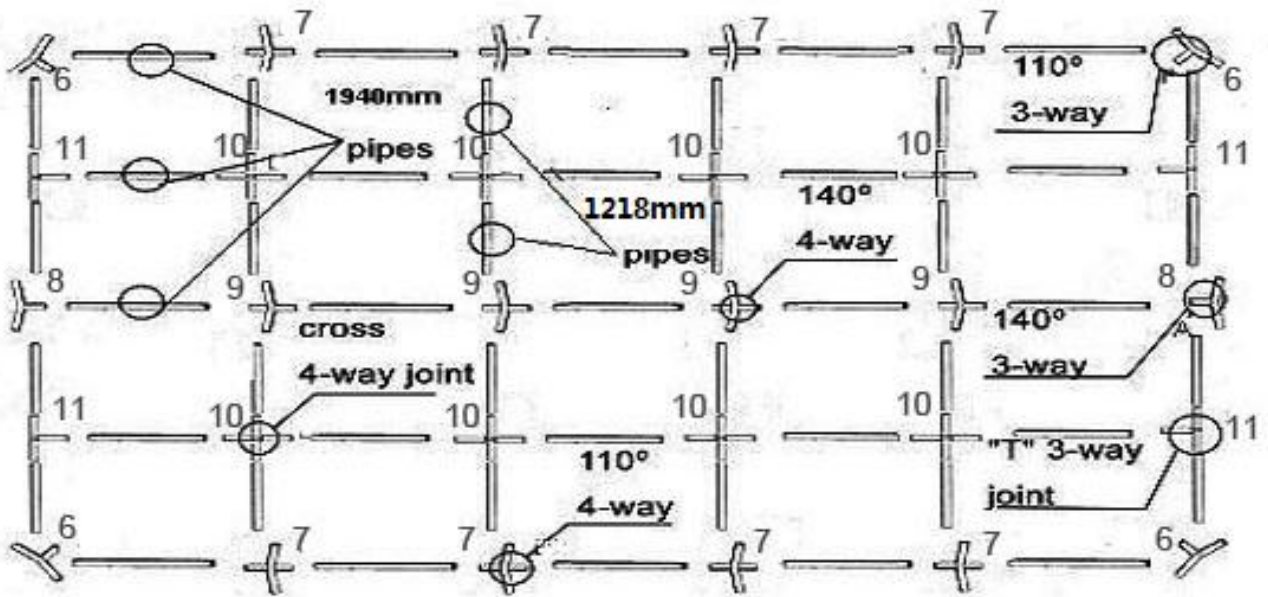

them.

2. Connect pipes together starting with the center frame. Then assemble each side.

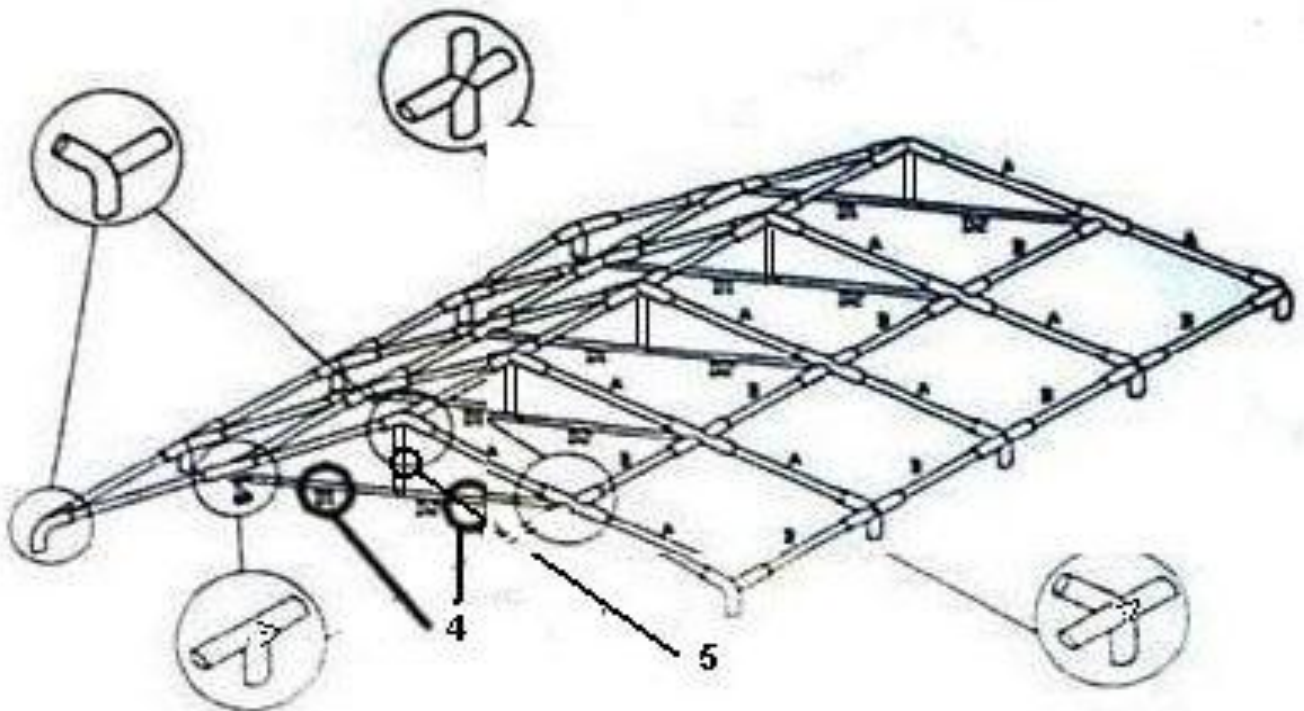

ATTACHING COVER TO FRAME

1. Start by lifting one of the frame and inserting legs.
2. Drape cover over frame.
3. Next, lift the other side of the frame and insert remaining legs.
4. Hung up the all side panels and door panels.

NOTE: *Loosen the straps on the bottom of the legs when attach the cover. Adjust as needed after the canopy is assembled.*

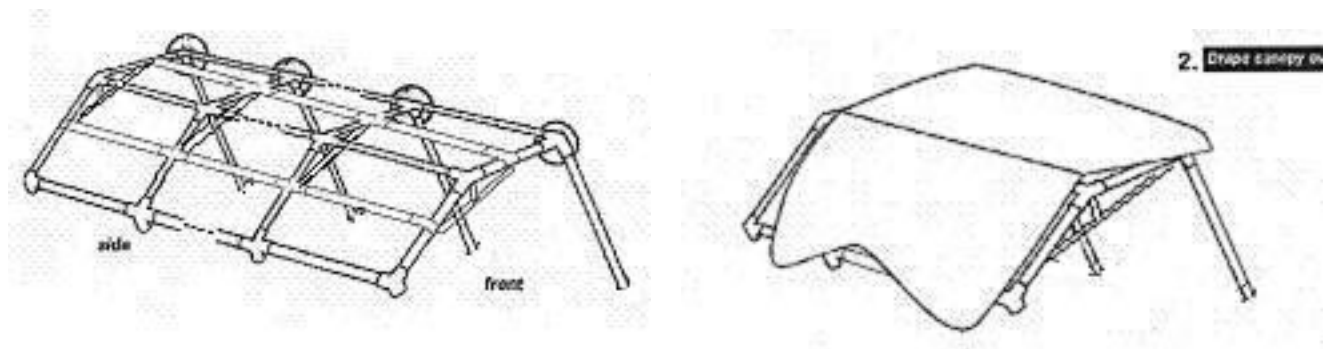

Insert the remaining legs and finish attaching cover to frame.

0. Then hung up the all side panels.and set up the foot and the ground bar.

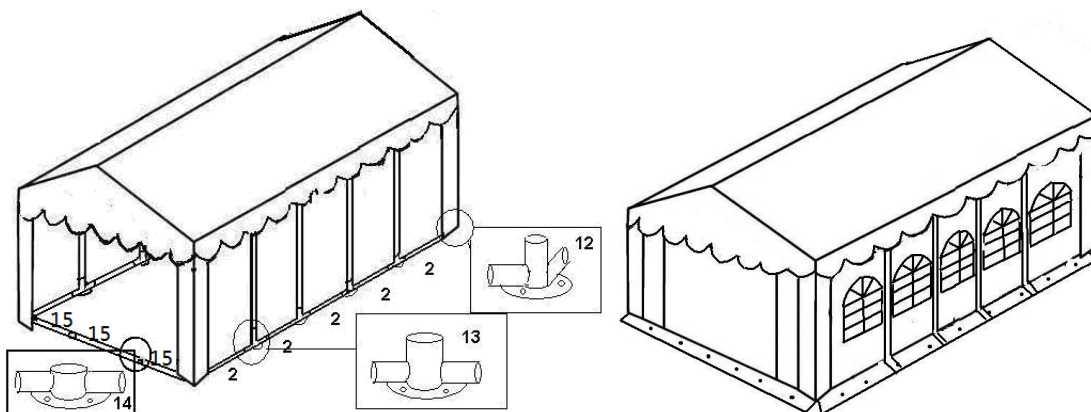

NOTE: USING TIR DOWNS OR PROPER ANCHOR KIT FOR YOUR NEEDS .

1. ATTENTION:

NEVER use below strap to tighten the roof and sidewall with window and sidewall with door, this will damage the grommet and fabric

