

7X15M PVC PART LIST

(1) Galvanized Pipe

Quantity 32



(2) Galvanized Pipe(with a hole)

Quantity 4



(3) Galvanized Pipe

Quantity 45



(4) Galvanized Pipe

Quantity 16

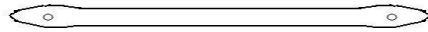

(5) Galvanized Pipe

Quantity 8

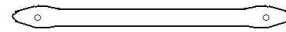

(6) Galvanized Pipe(with a hole)

Quantity 4



(7) Galvanized Pipe

Quantity 12



(8) Galvanized Pipe

Quantity 6



(9) Galvanized Pipe

Quantity 4

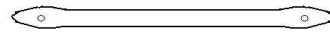

(10) 140° 3 Way joints

Quantity 2

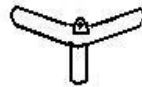

(11) 110° 3 Way joints

Quantity 2



(12) 110° 3 Way joint

Quantity 2



(13) 140° 4 Way joints

Quantity 6

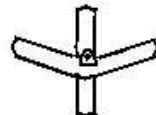

(14) 110° 4Way joints

Quantity 12



(15) 3 Way joints

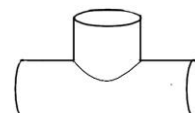

Quantity4

(16) Cross 4 Way joints

Quantity 12

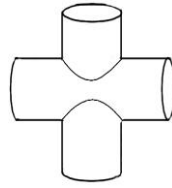

(17) 3 Way joints

Quantity 2

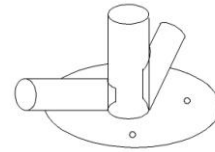

(18) 3 Way joints

Quantity 2

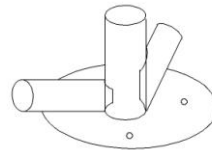

(19) 3 Way joints

Quantity 12

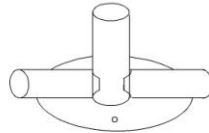

(20) NO.14 3 Way joints

Quantity 4

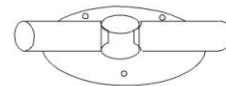

(21) Top Cover

Quantity 1

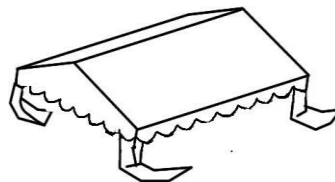

(22)Side Panels

Quantity 14

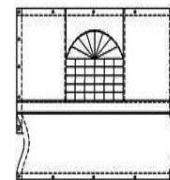

(23)Door Panels

Quantity 2

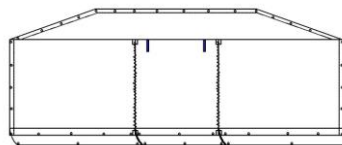

(24)Steel wire and turn buckle

56pcs

28pcs



7X15M S STRUCTURE TENT

INSTRUCTION

FRAME ASSEMBLY

- Place all joints 、 leg pipes and window pipes and connection pipe on the ground as shown. Push two pipes into the joints, use screws fix them. (More important, use steel wire and turn buckle(24) to go though the holes on Pipe No.1, pls do not tighten the turn buckle until you put all wire on.)

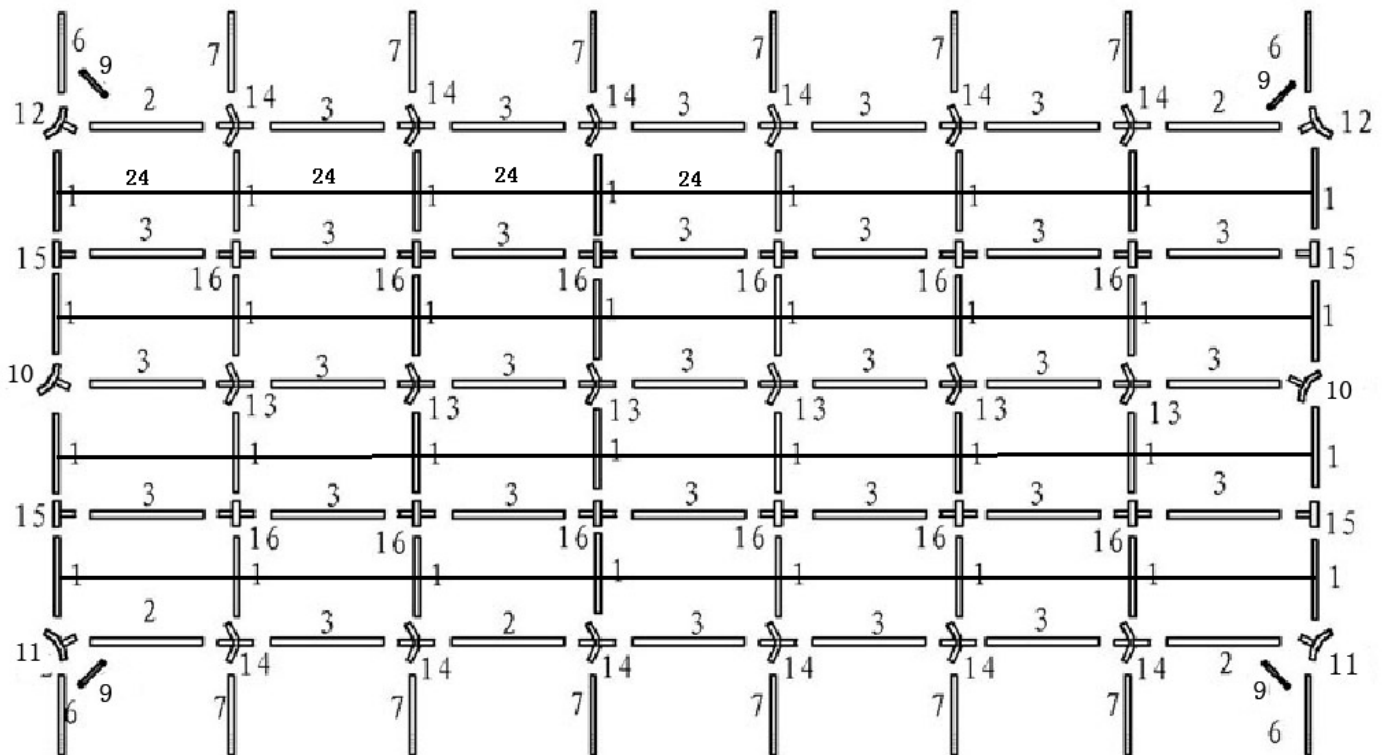



7X15M S STRUCTURE TENT INSTRUCTION

FRAME ASSEMBLY

2. Connect pipes together starting with the center frame. Then assemble each side

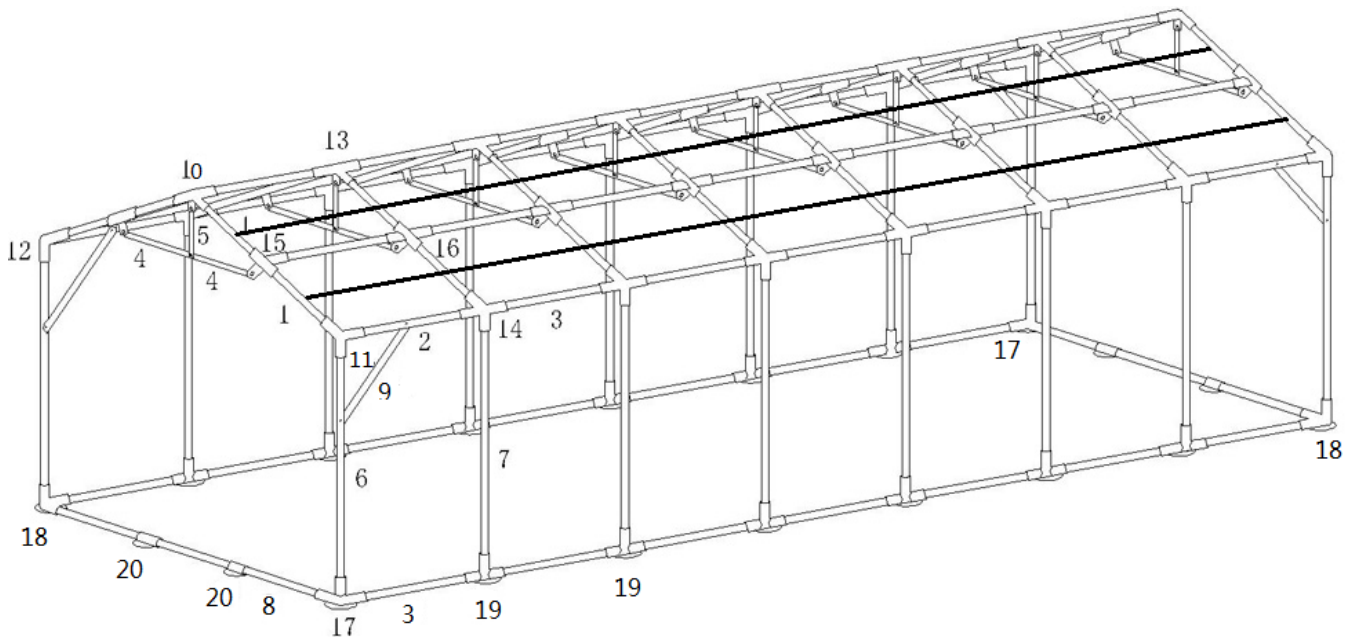

ATTENTION:

NEVER use below strap to tighten the roof and sidewall with window and sidewall with door, this will damage the grommet and fabric



ATTACHING COVER TO FRAME

1. Start by lifting one of the frame and inserting legs.
2. Drape cover over frame.
3. Next, lift the other side of the frame and insert remaining legs.
4. Hung up the all side panels and door panels.

NOTE: *Loosen the straps on the bottom of the legs when attach the cover. Adjust as needed after the canopy is assembled.*

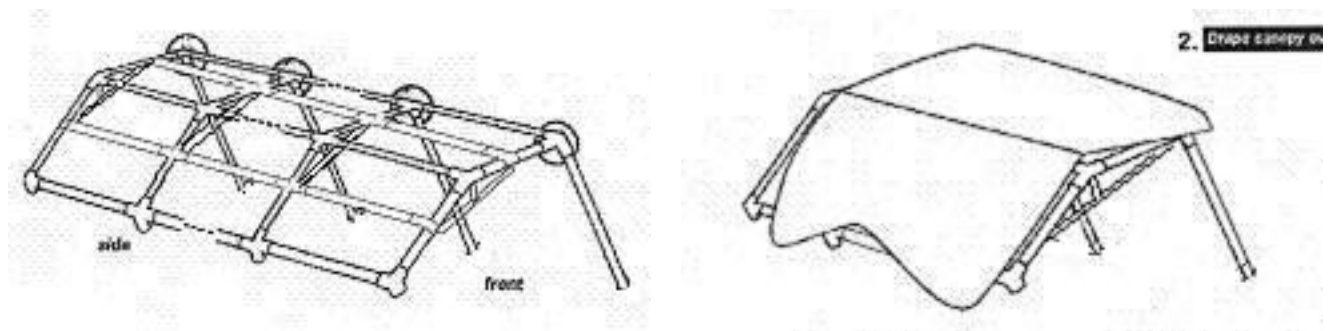

Insert the remaining legs and finish attaching cover to frame. Then hung up the all side panels. and set up the foot and the ground bar.

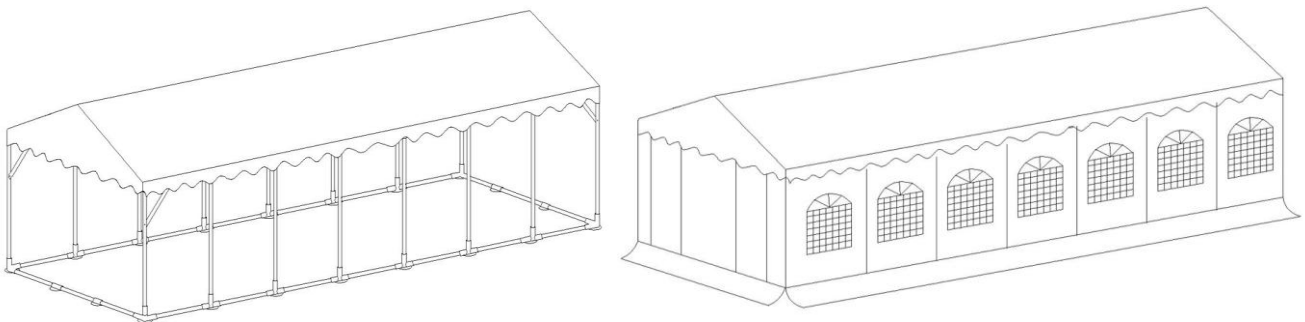

NOTE: USING TIR DOWNS OR PROPER ANCHOR KIT FOR YOUR NEEDS .