

6X6M PARTY TENT PART LIST

NO. 1 4'10" Galvanized Pipe

Quantity 16



NO. 2 6'4" Galvanized Pipe

Quantity 15



NO. 3 6'4" Galvanized Pipe

Quantity 8

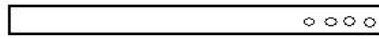

NO. 4 6'4" Galvanized Pipe

Quantity 8

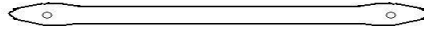

NO. 5 6'4" Galvanized Pipe

Quantity 4

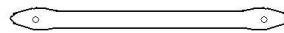

110° 3 Way joint 6

Quantity 4



110° 4Way joints 7

Quantity 4

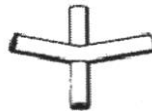

140° 3 Way joints 8

Quantity 2



140° 4 Way joints 9

Quantity 2

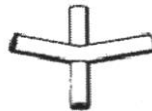

Cross 4 Way joints 10

Quantity 4

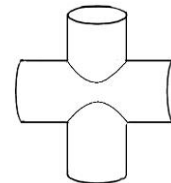

"T" 3 Way joints 11

Quantity 4

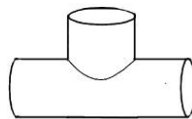

foot

Quantity 8

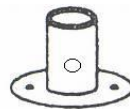

Top Cover

Quantity 1

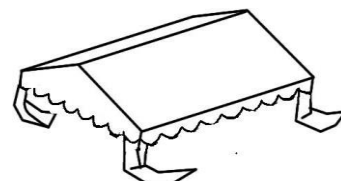

Side Panels

Quantity 2



Door Panels

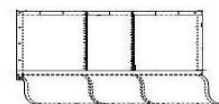

6X6M STRUCTURE GALA TENT INSTRUCTION

FRAME ASSEMBLY

1. Place all joints, 1940mm pipes and 1470mm pipes on the ground as shown.

Push two pipes into the joints, use screws fix them.

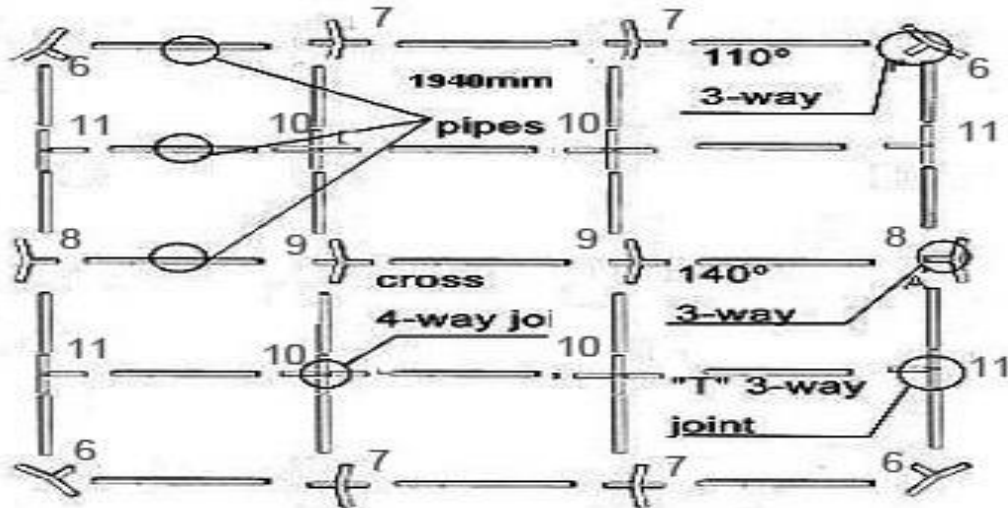

2. Connect pipes together starting with the center frame. Then assemble each side.

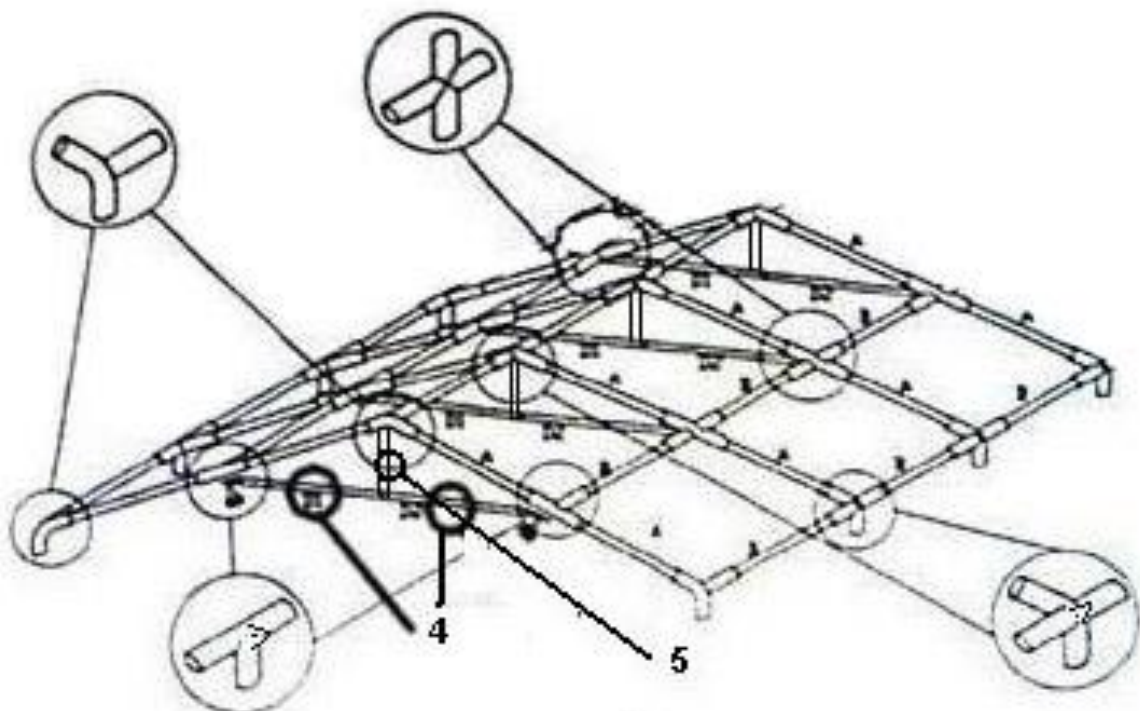

ATTACHING COVER TO FRAME

1. Start by lifting one of the frame and inserting legs.
2. Drape cover over frame.
3. Next, lift the other side of the frame and insert remaining legs.
4. Hung up the all side panels and door panels.

NOTE: *Loosen the straps on the bottom of the legs when attach the cover. Adjust as needed after the canopy is assembled.*

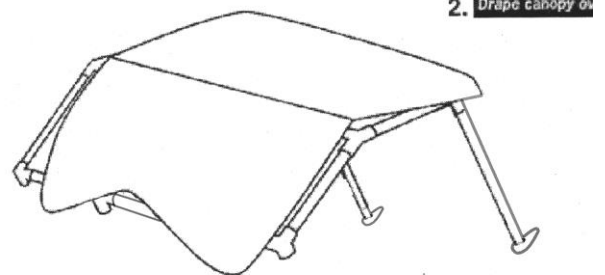
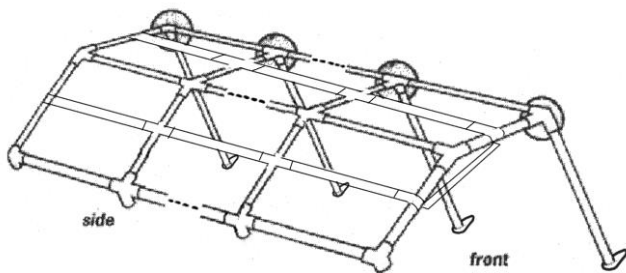

Insert the remaining legs and finish attaching cover to frame.

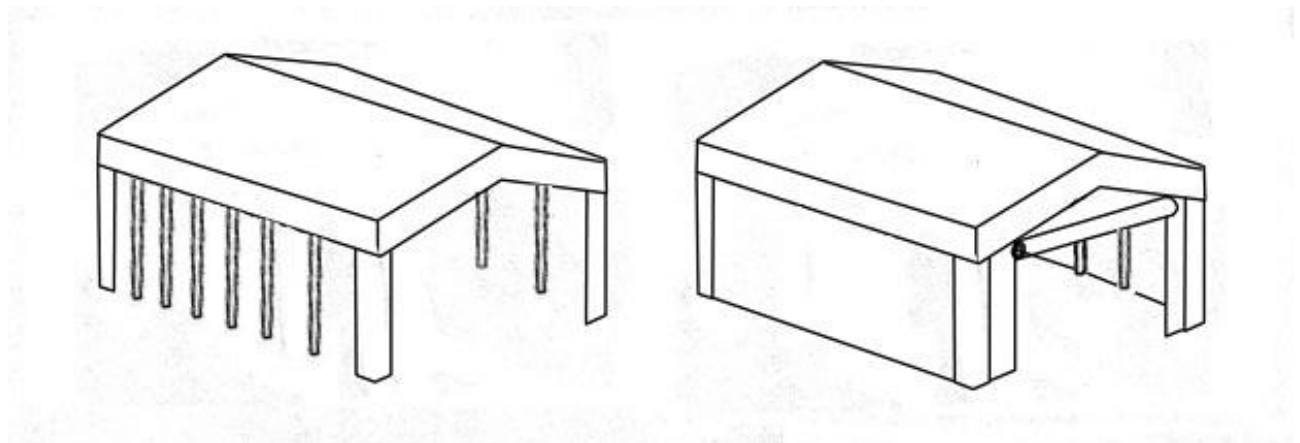

Then hung up the all side panels.

NOTE: USING TIR DOWNS OR PROPER ANCHOR KIT FOR YOUR NEEDS.