

GH08

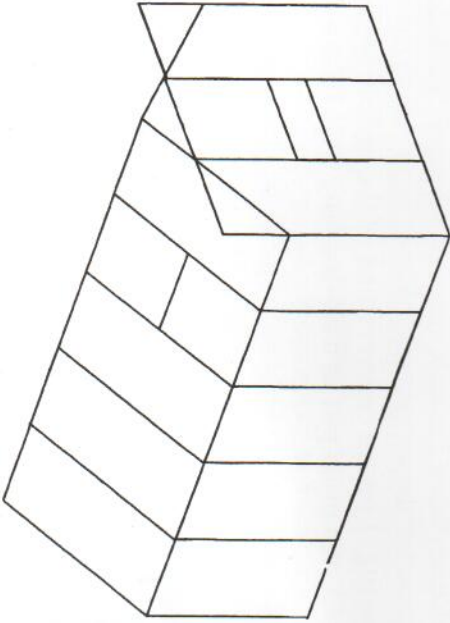

GH09

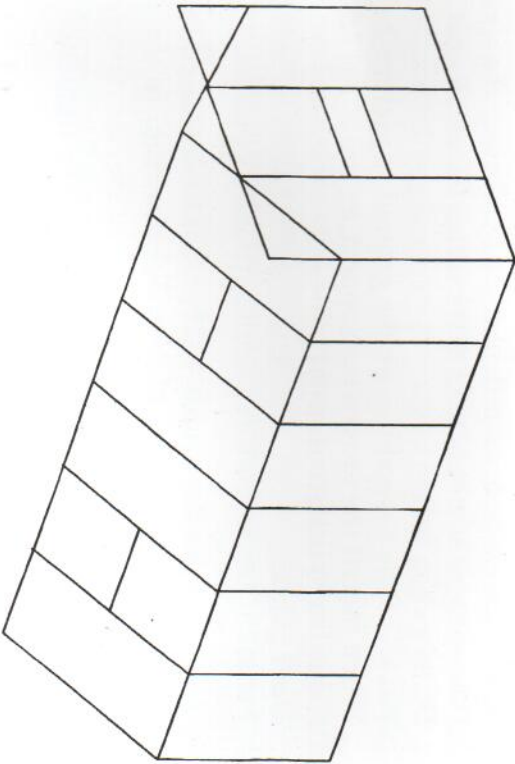

GH10

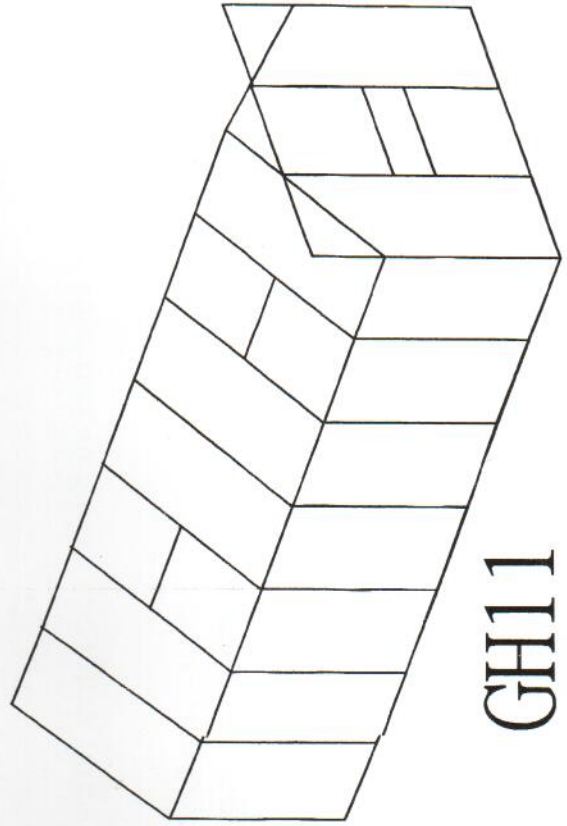

GH11

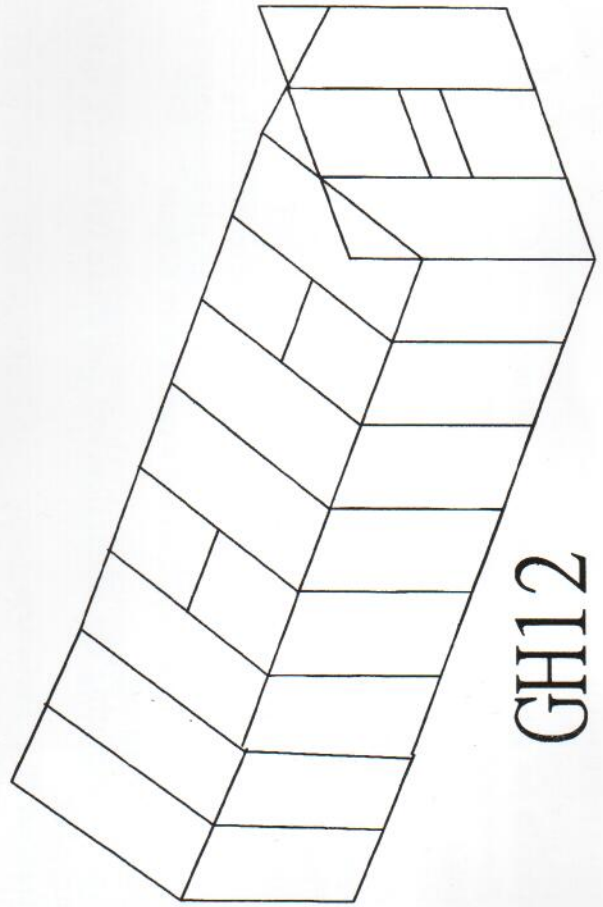

GH12

- 1, Thanks for selecting our products. Please read the introduction before construction.
 - 2, Please wear gloves during work to escape the sharp corners' hurt.
 - 3, Used to raise plants only! We can't assume any responsibility for any other usages!
 - 4, No less than 2 operators work together when installing!
 - 5, Any problem in installing, please contact with the distributors.
- Do not instruct by force!

- 1, Proper place full of sunshine and against the wind!
- 2, Important introduction.

Do check all units on list complete or not before installing the raising-house. Take out the belted part of the package, you may identify each unit according to the marks on it. Any shortage, please contact with the supplier!

- 3, Necessary tools: one spin, a bolt wrench with 8-9mm
- 4, Serious warning.

After completing the instruction, you can clean the house again with neutral detergents having no corrosion to aluminum frame and pinchcock.

Infrastructural facilities:

When used, infrastructural facilities must be at right angles to the horizontal and vertical.

When using following with our products, you can instruct according to the eighth part of introduction.

Attention! If there is poor protection and strong wind near the house, please install all 8-F sets according to the eighth part of the introduction. Please drill in proper place in order to connect the raising house and infrastructural facilities tightly.

Side units

Put all of the units on the ground as picture 1 showing. Loosen connections of the bolt to make them connect with each other.

Attention! When install unit 1015 fitting the inclined-supporting unit 1012, we must put in a no-loading bolt first as picture 1.1 showing, or it would take difficulties to install unit 1012.

Blind gable.

Put all of the assemblies on the ground as picture 2 showing. Loosen connections of the bolt to make them connect with each other.

When install the crosswise supporting units 1017&1013, we must put in a no-loading bolt first as picture 1.1 showing, or it would take difficulties to install unit 1013.

Door gable.

Put all of the assemblies on the ground as picture 3. Loosen connections of the bolt to make them connect with each other.

Slideway of the door, unit 1029, must be installed to the horizontal orbit on the top of the door. Loosen 2 bolts on the orbit and make it sliding into unit 1029 as picture 3.4 showing. In the direction of opening the door, you can correct and tighten the slideway by turning right or left.

Attention! As picture 3.5 & 3.6 showing, the tightened bolt is used to limit the sliding range.

Units combination

Join side and corner units together as showing in pictures 4.7&4.2.

After installing roof, unit 1036, should install the units in picture 4.4/4.3 as showing in picture 4.5.

Attention! Before installing roof-supporting units to match the top window, must install a no-loading bolt first, or it would take difficulties for installing the top window. Before installing every roof-supporting unit of model 75, must install a no-loading bolt first in order to install & tighten unit 1036.

Put the completed house on the infrastructural facilities and keep flexible. Use 8-F unit to connect the two parts. Check the raising house to be right angle type or not. Any defect, must adjust it according translation and then tighten the bolt but should not too tight. Install the protective cover onto the frame 4.1, and connect the supporting units of slideaway & gable wall.

Door.

Push unit 1055 of two doors into unit 1044 as picture 5.4 showing, install the rolling unit 1056 top of the door as picture 5.1 showing and install the units of door as picture 5 showing. After assembling the door, push the door into the slideaway, keep both the top & bottom of the door inside of the slideaway. After completing the door, equip a bolt, door-stopping unit, to the slideaway's end and adjust the door in order to move smoothly as picture 3.6 showing.

Top window.

Assembly top window as picture 6.1/6.2.6.3 showing, and install unit 1061. Attention! The top window must be at right angle.

Install units 1052&1050 as picture 6.6 showing, and push them into top window as as picture 6.5 showing. Test the top window in the correct position or not according picture 6.7.

Pave clapboard.

Install all clapboards as picture 7 showing, and pave beads as picture 7.2/7.3/7.4/7.5/7.6/7.7/7.8 showing. Pressurize spring as picture 6.7 showing.

Remove approximately 5cm from all edges of protective film before installing. And remove the protective film immediately after completing the installation. Then cover again to protect the panel surface until completing the construction.

Attention!

Strictly forbid to use sharp tools when remove the protective film.

Do not walk on the the clapboard!

Do not contact with alkalines, alkali salts, amines ketones, aldehydes, esters, chlorinated hydrocarbons, aromatic hydrocarbons, methanol, isopropanol, asphalt, putty and so on.

Final hand operation.

Use silica gel to seal the seam of raising house when necessary. The silica gel is not involved in our supplying range.

Put up posters on the wall inside of the house.

Any fittings' problem, please contact with the distributor.











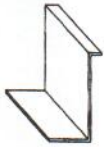

Advice.

Please close the door and windows in strongly windy day!

Advise to buy housing insurance just in case.

After completing the instruction, please put up identified marks in proper position of the house.

Please keep this installing introduction!

NO.	mm	MODEL					Sektion
		08	09	10	11	12	
1001		1	1	1	1	1	3
1002		2					1
1003			2				1
1004				2			1
1005					2		1
1006						2	1
1007		2					1
1008			2				1
1009				2			1
1010					2		1
1011						2	1
1012		2	2	2	2	2	1-3
1013		1	1	1	1	1	2
1014		2	2	2	2	2	3
1015		6	8	10	12	14	1
1016		6	8	10	12	14	4
1017		1	1	1	1	1	2
1018		1	1	1	1	1	2
1019		1	1	1	1	1	2
1020		1	1	1	1	1	3
1021		1	1	1	1	1	3
1022		1	1	1	1	1	3
1023		4	4	4	4	4	2-3
1024		1	1	1	1	1	2
1025		1	1	1	1	1	2
1026		1	1	1	1	1	3
1027		1	1	1	1	1	3
1028		4	4	4	4	4	2-3
1029		1	1	1	1	1	3
1030		9	12	15	18	21	4
1031		2	2	2	2	2	4
1032		2	2	2	2	2	5
1033		1					4
1034			1				4
1035				1			4
1036					1		4
1037						1	4

NO.	mm	MODEL					Sektion
		08	09	10	11	12	
1038		4	4	4	4	4	5
1039		4	4	4	4	4	5
1040		4	4	4	4	4	4
1041		2	2	2	2	2	2
1043		2	2	2	2	2	5
1044		2	2	2	2	2	5
1047		2	4	4	8	8	6
1048		1	2	2	4	4	6
1049		1	2	2	4	4	6
1050		1	2	2	4	4	6
1051	M6X10	110	124	154	200	250	1-6
1052		2	4	4	8	8	6
NO.	mm	MODEL					Sektion
		08	09	10	11	12	
1053		4	4	4	4	4	5
1055		4	4	4	4	4	5
1056		4	4	4	4	4	5
1057	-	210	240	270	305	350	7
1058		2	2	2	2	2	4
1059	No.6X6	6	12	12	24	24	5
1060	M6	110	130	160	200	250	1-6
1061		1	2	2	4	4	6
1062		2	2	2	2	2	4
1063	M4	4	4	4	4	4	5
1064	M4X16	4	4	4	4	4	5
1065	No.6X16	32	32	32	32	32	5
A-A		4	4	4	4	4	5

MODEL	08	09	10	11	12
1002	1003	1004	1005	1006	
2	2	2	2	2	
1007	1008	1009	1010	1011	
2	2	2	2	2	
1040	4	4	4	4	
1015	6	8	10	12	14
1030	6	8	10	12	14
1060					
1051					

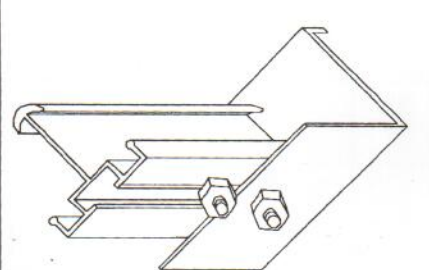
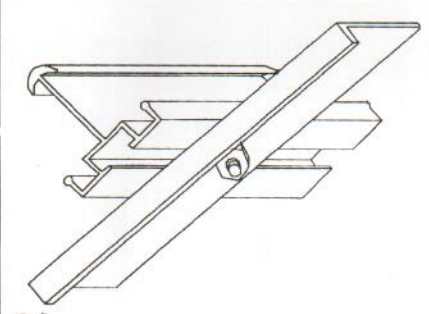
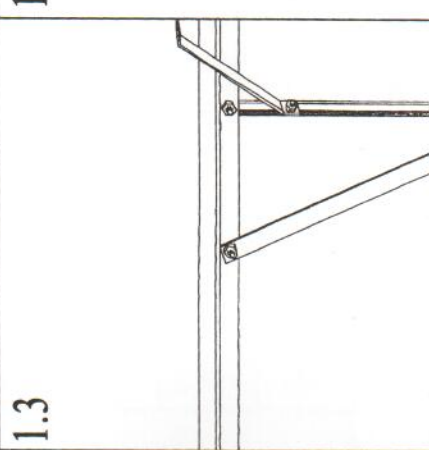
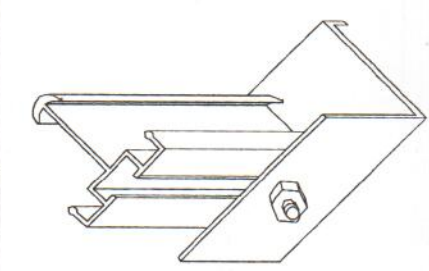
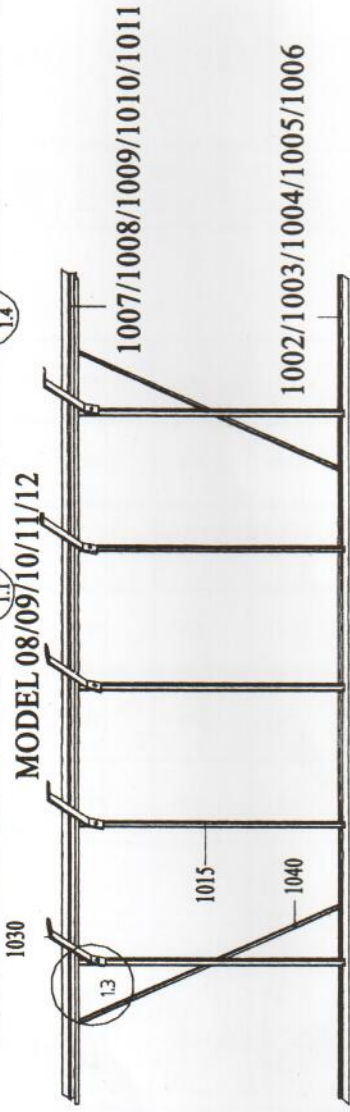
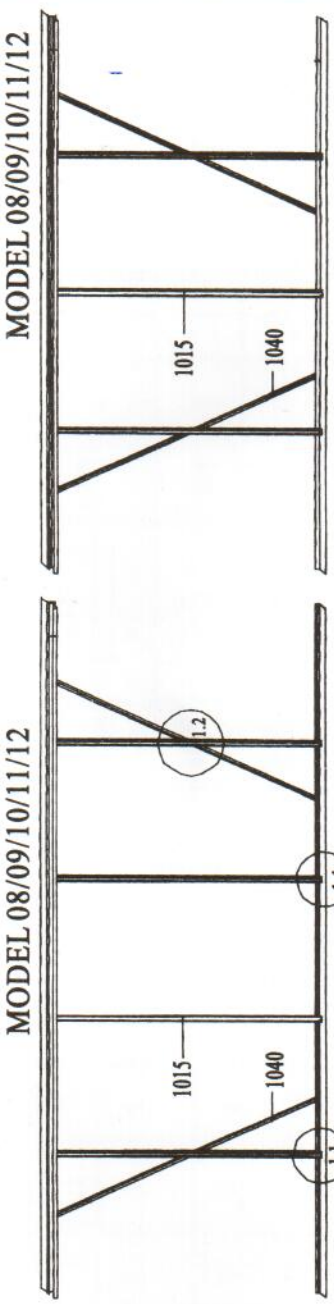

1

1.1









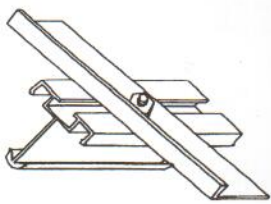















1.2

1.3

1.4

2.1



2		1019
		1
		1041
		2
		1023
		1
		1023
		1
		1024
		1
		1025
		1
		1013
		1
		1017
	1	
	1018	
	1	
	1028	
	2	
	1060	
	18	
	1051	
	18	

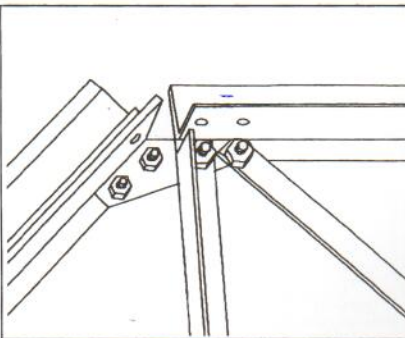
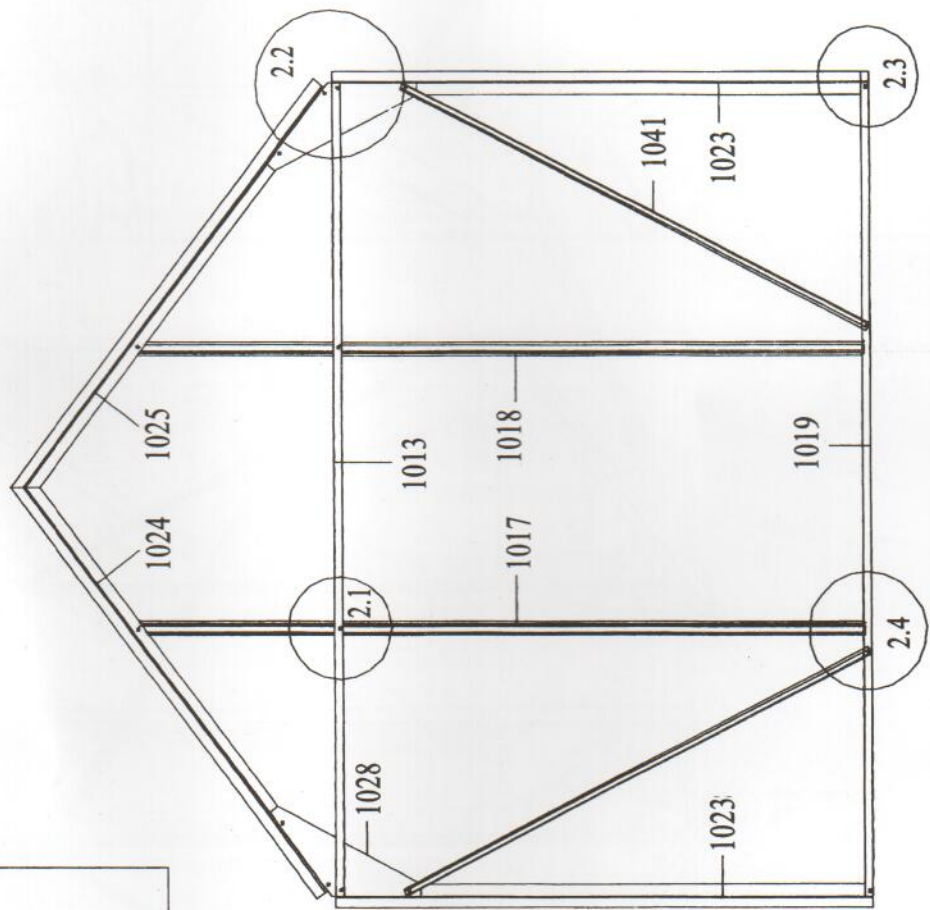

2.3

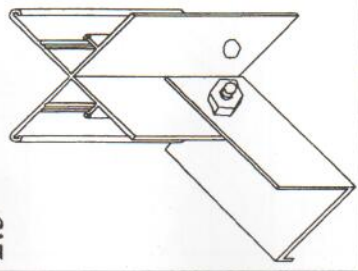



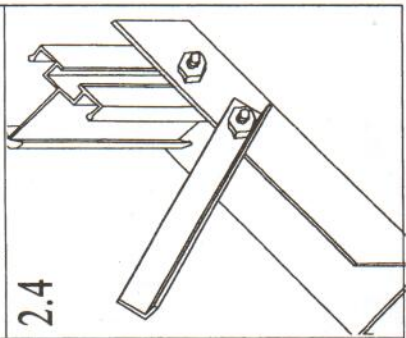

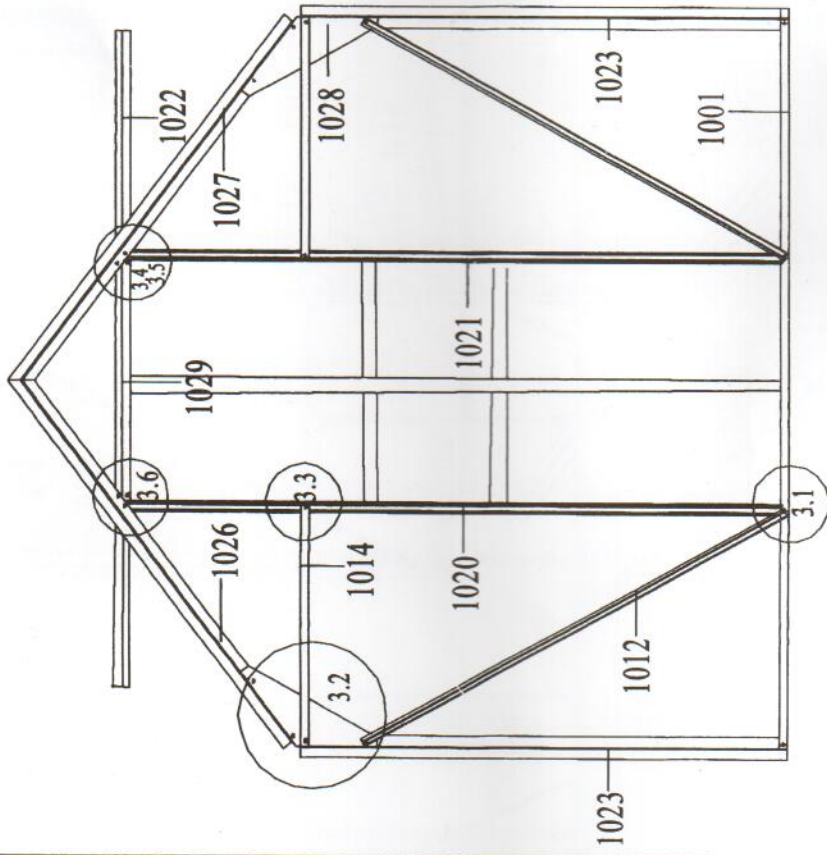
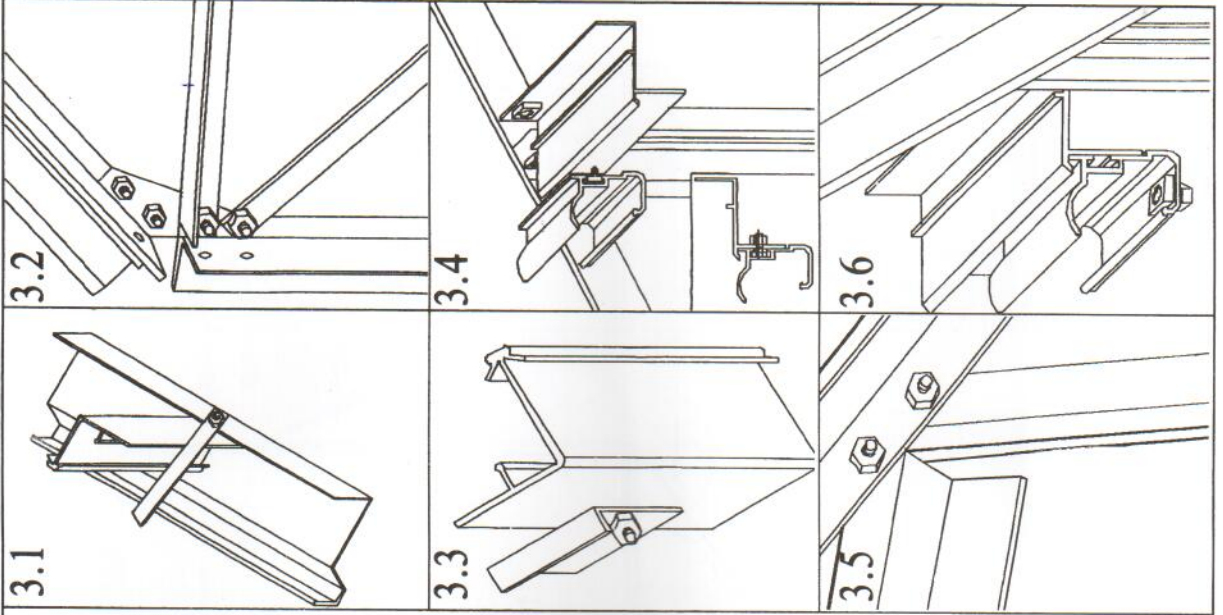









2.4





3







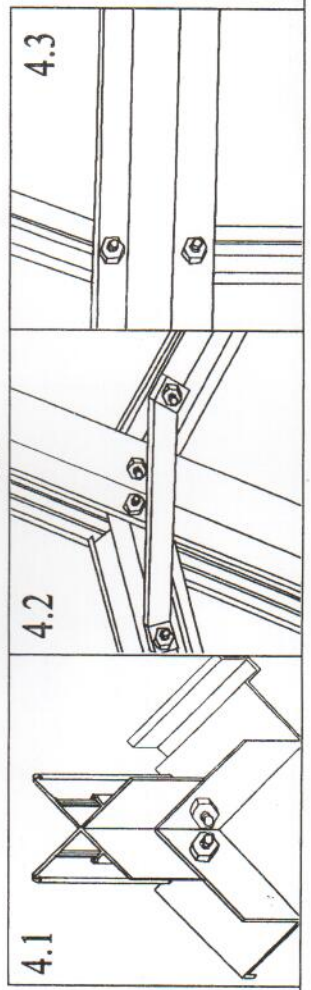
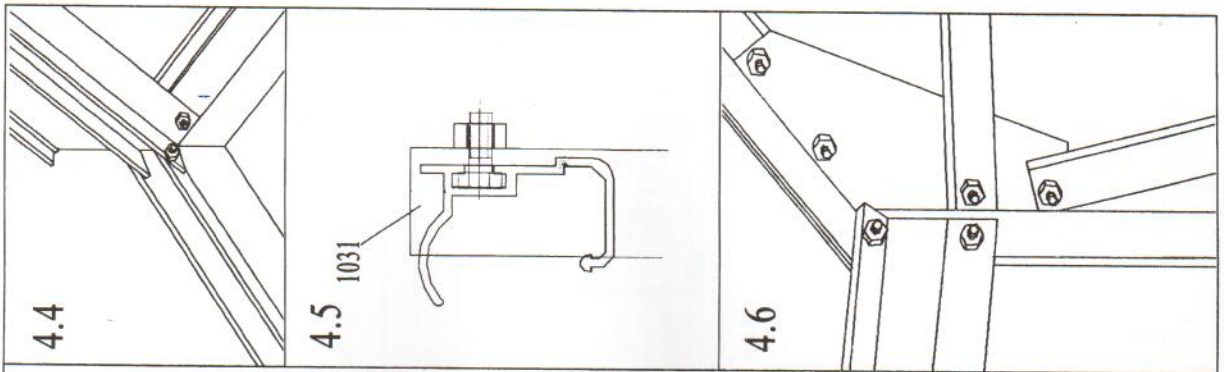
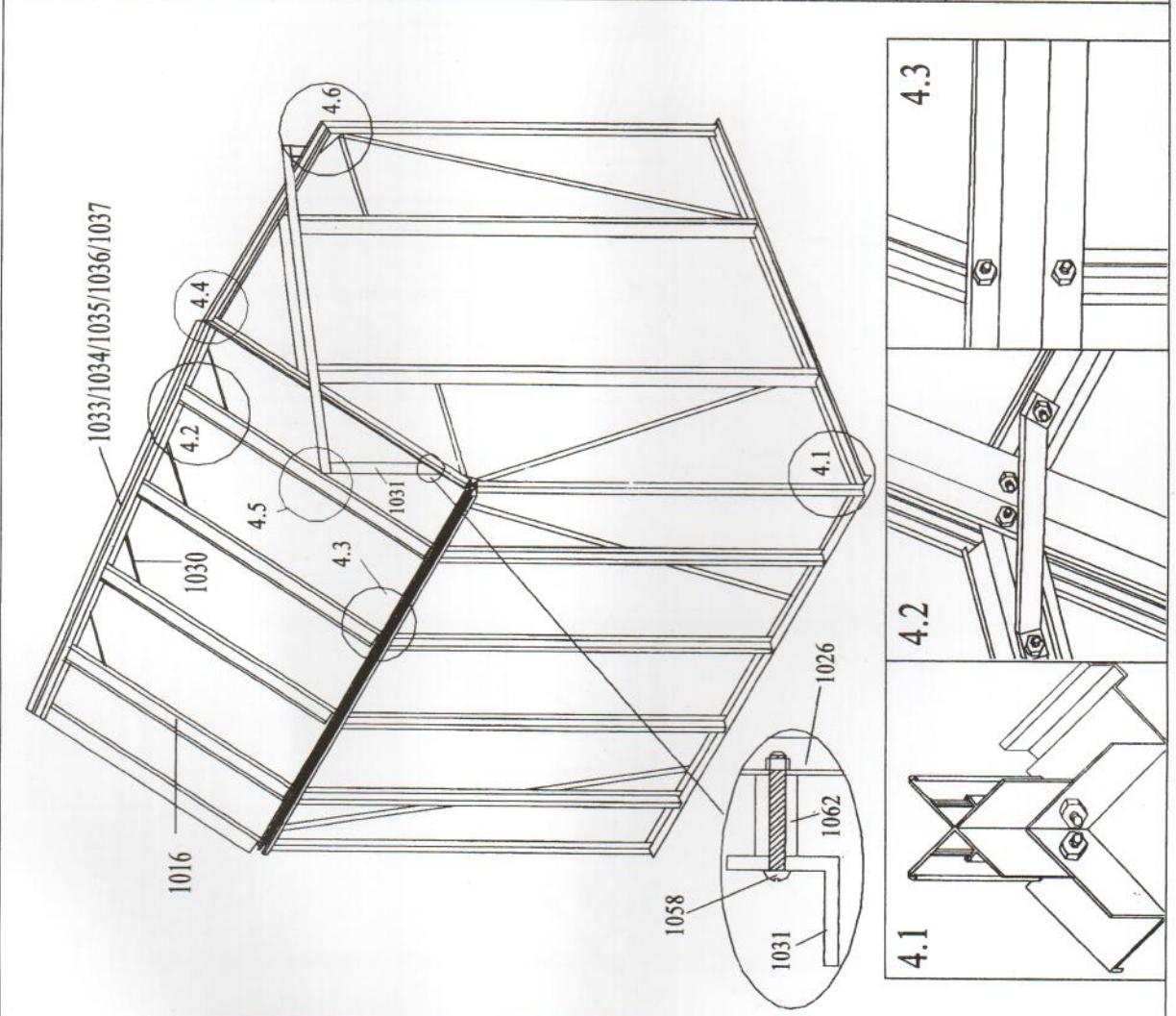



















													
1001	1002	1023	1023	1020	1021	1022	1026	1027	1014	1029	1028	1060	1051
1	2	1	1	1	1	1	1	1	1	2	2	18	18

4

MODEL	08	09	10	11	12
1033 1034 1035 1036 1037	1	1	1	1	1
1031	2	2	2	2	2
1016	6	8	10	12	14
1030	3	4	5	6	7
1060	23	29	45	51	57
1051	23	29	45	51	57
1062	2	2	2	2	2
1058	2	2	2	2	2



5

	1032
	2
	1043
	2
	1039
	4
	1038
	4
	1044
	2
	1056
	4
	1064
	4
	1053
	4
	1055
	4
	1065
	32
	1060
	4
	1051
	4
	1063
	4
	A-A

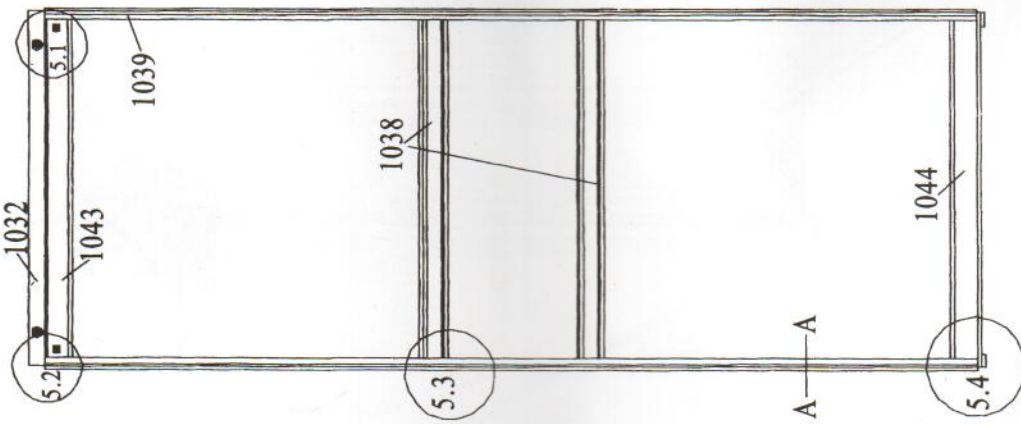

5.1

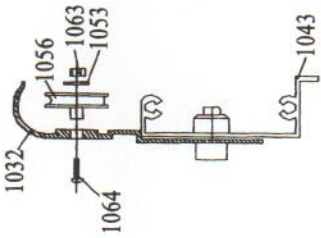

5.4

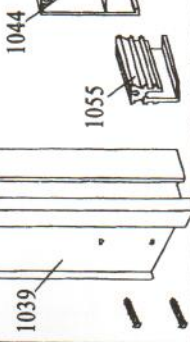

5.2

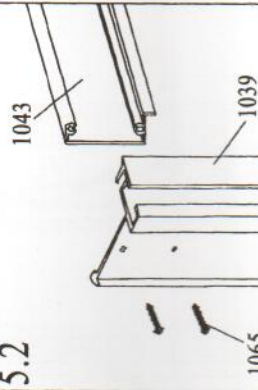

5.5

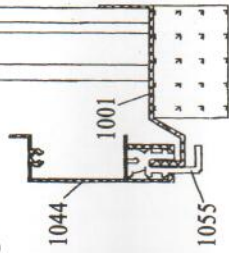

5.3

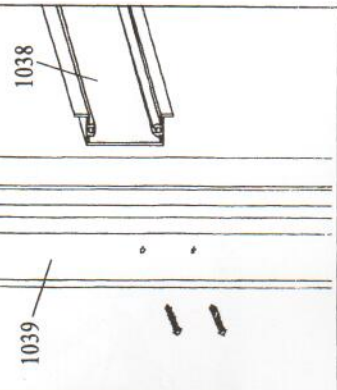

A-A

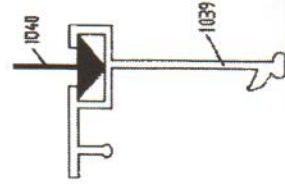

6

6.6

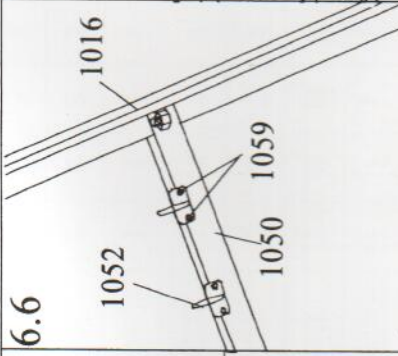

6.5

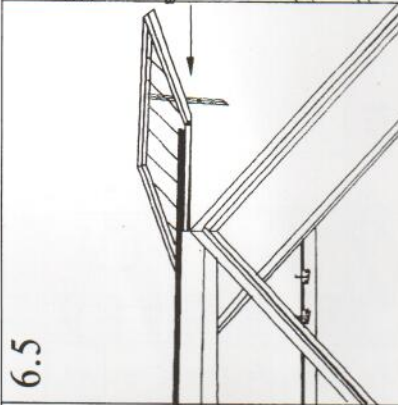

6.4

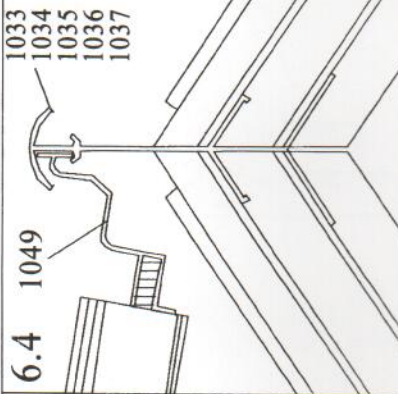

6.1

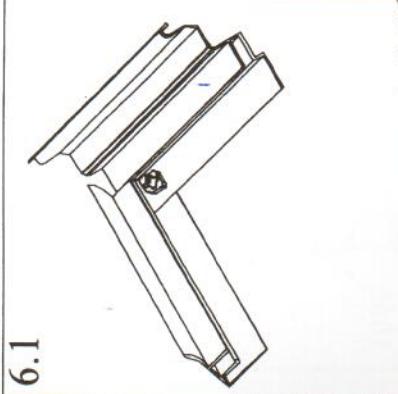

6.7

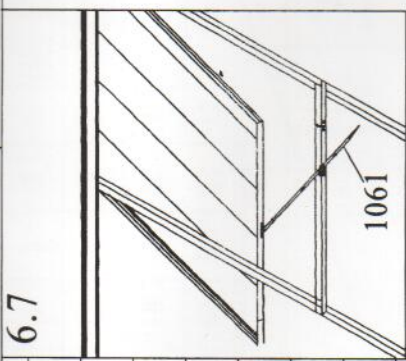

6.2

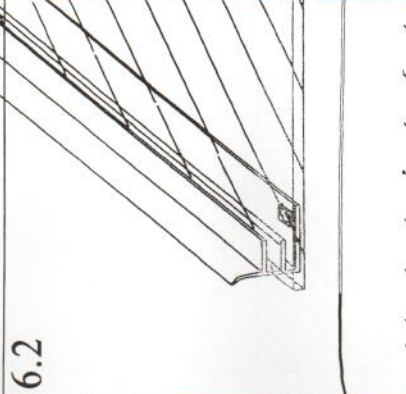

6.3

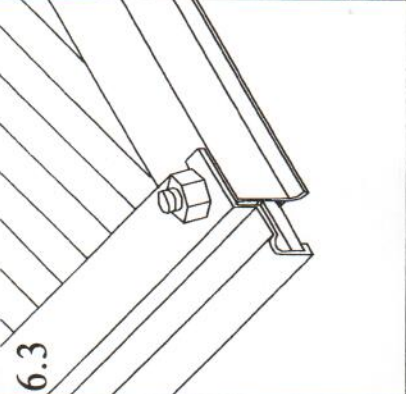

MODEL	08	09	10	11	12
1047	2	2	4	4	4
1049	1	1	2	2	2
1049	1	1	2	2	2
1050	1	1	2	2	2
1052	2	2	4	4	4
1059	6	6	12	12	12
1061	1	1	2	2	2
1060	4	4	8	8	8
1051	4	4	8	8	8

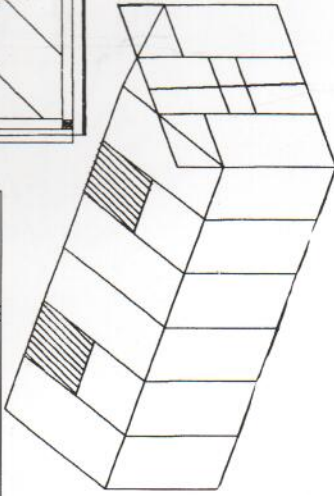

7

This page is replacing Step 7 in the User Manual. All parts listed under Step 7 are no longer in use and are not included in the box.

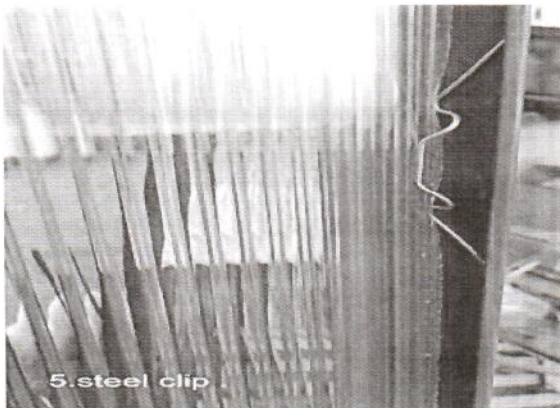
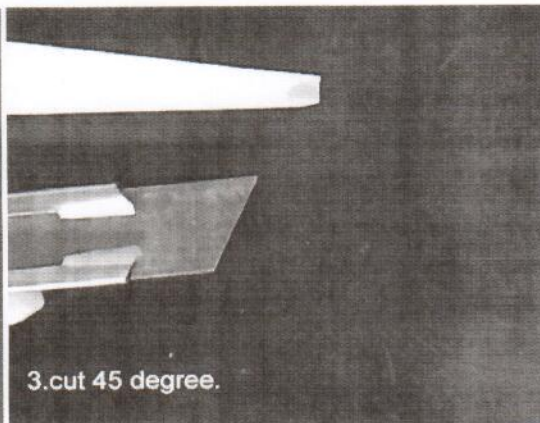
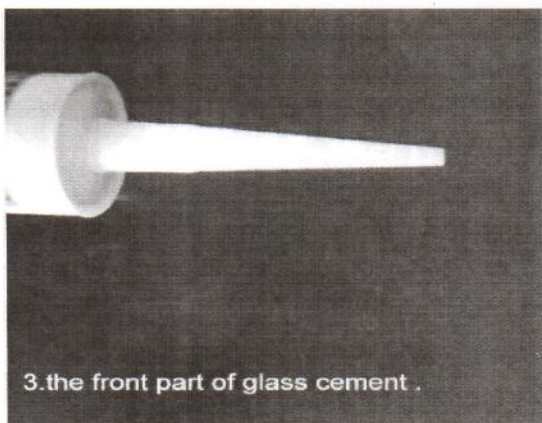
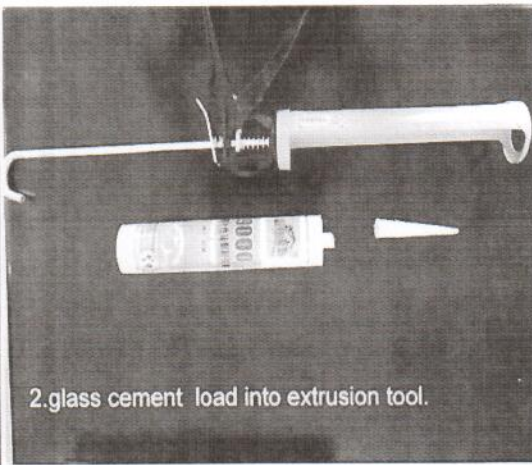

8

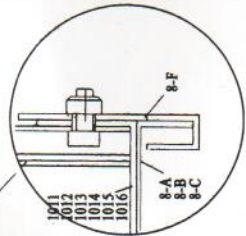
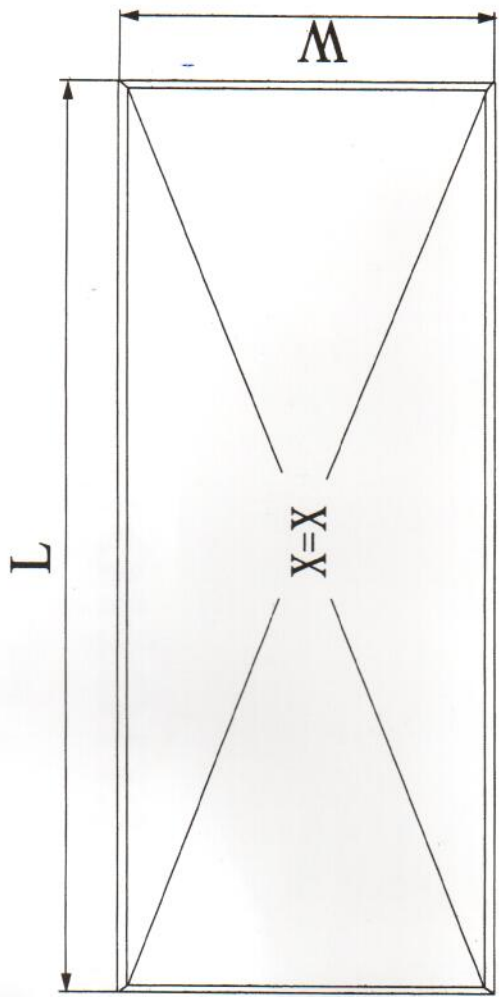

MODEL	08	09	10	11	12
8-A	-	-	-	-	-
8-B	4	4	4	4	4
8-C	-	-	-	-	-
8-D	4	4	4	4	4
8-E	4	4	4	4	4
8-F	14	16	18	20	22
1060	32	32	32	32	32
1051	32	32	32	32	32

