

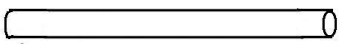

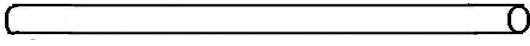

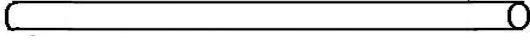

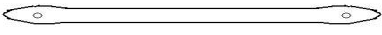
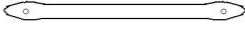

6x 2 PARTY TENT

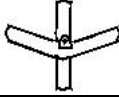
1.	Frame Pole		4
2.	Frame Pole		7
3.	Support Pole		2
4.	Top strength pipe long		2
5.	Top strength pipe short		1
7.	110 degree 4 way Connector		2
9.	140 degree 4 way connector		1
10.	Flat 4 way connector		2
13.	Ground middle connector		2
17.	6x180mm Peg		2
18.	4x180mm Peg		6
19.	Long bungee ball		36
21.	Wing nut		4
22.	Finger screw		30
23.	roof		1
24.	Sidewalls		2

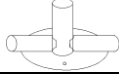
1.
 Select an area of flat ground for the tent. Unpack the carton and check all parts including tubes, tent and accessories... etc. are present.
 Assemble the roof top framework by joining the (6,7,8,9,10,11) Connectors together with poles (1,2,3,4,5). Ensure the tension screw is fixed to every pole tightly. Use the turn buckle and steel wire to tighten the frame. Before you put all on, do not tighten them.

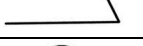
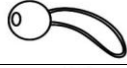
6x 2 PARTY TENT

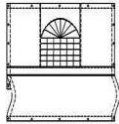
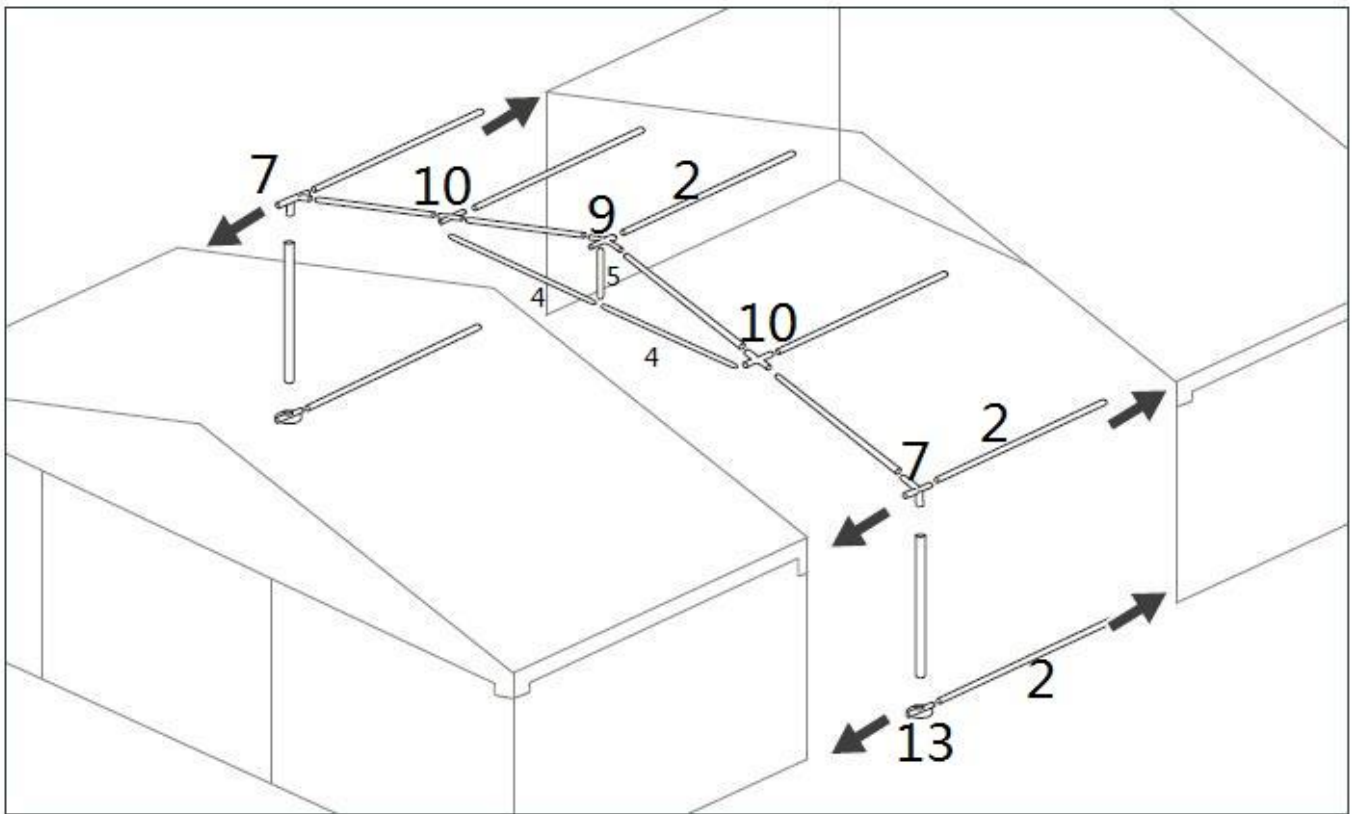

2. cover the roof on the top frame, and sidewall and endwall like 6X4M basic section. Add more expansion section to make your tent more bigger.