

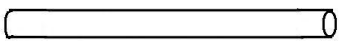

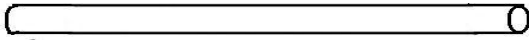

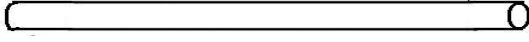

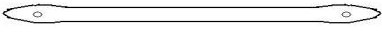

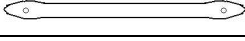

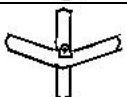

6x 4 PARTY TENT

1.	Frame Pole		12
2.	Frame Pole		20
3.	Support Pole		6
4.	Top strength pipe long		6
5.	Top strength pipe short		3
6.	110 degree 3 way Connector		4
7.	110 degree 4 way Connector		2
8.	140 degree 3 way connector		2
9.	140 degree 4 way connector		1
10.	Flat 4 way connector		2
11.	Flat 3 way connector		4
12.	Ground corner connector		4
13.	Ground middle connector		2
14.	Ground door connector		4
15.	Guy line		4
16.	Spiral peg		4
17.	6x180mm Peg		6
18.	4x180mm Peg		30
19.	Long bungee ball		110
20.	Short Bungee Ball		26
21.	Wing nut		12
22.	Finger screw		88
23.	roof		1

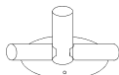
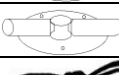
6x 4 PARTY TENT

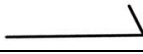
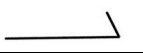
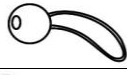
24.	Sidewalls		4
25.	End walls		2

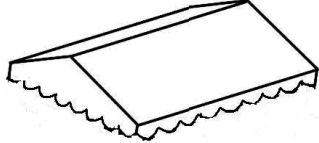
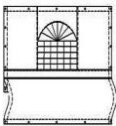
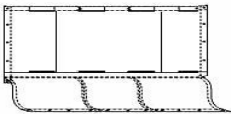
1.
 Select an area of flat ground for the tent. Unpack the carton and check all parts including tubes, tent and accessories... etc. are present.
 Assemble the roof top framework by joining the (6,7,8,9,10,11) Connectors together with poles (1,2,3,4,5). Ensure the tension screw is fixed to every pole tightly. Use the turn buckle and steel wire to tighten the frame. Before you put all on, do not tighten them.

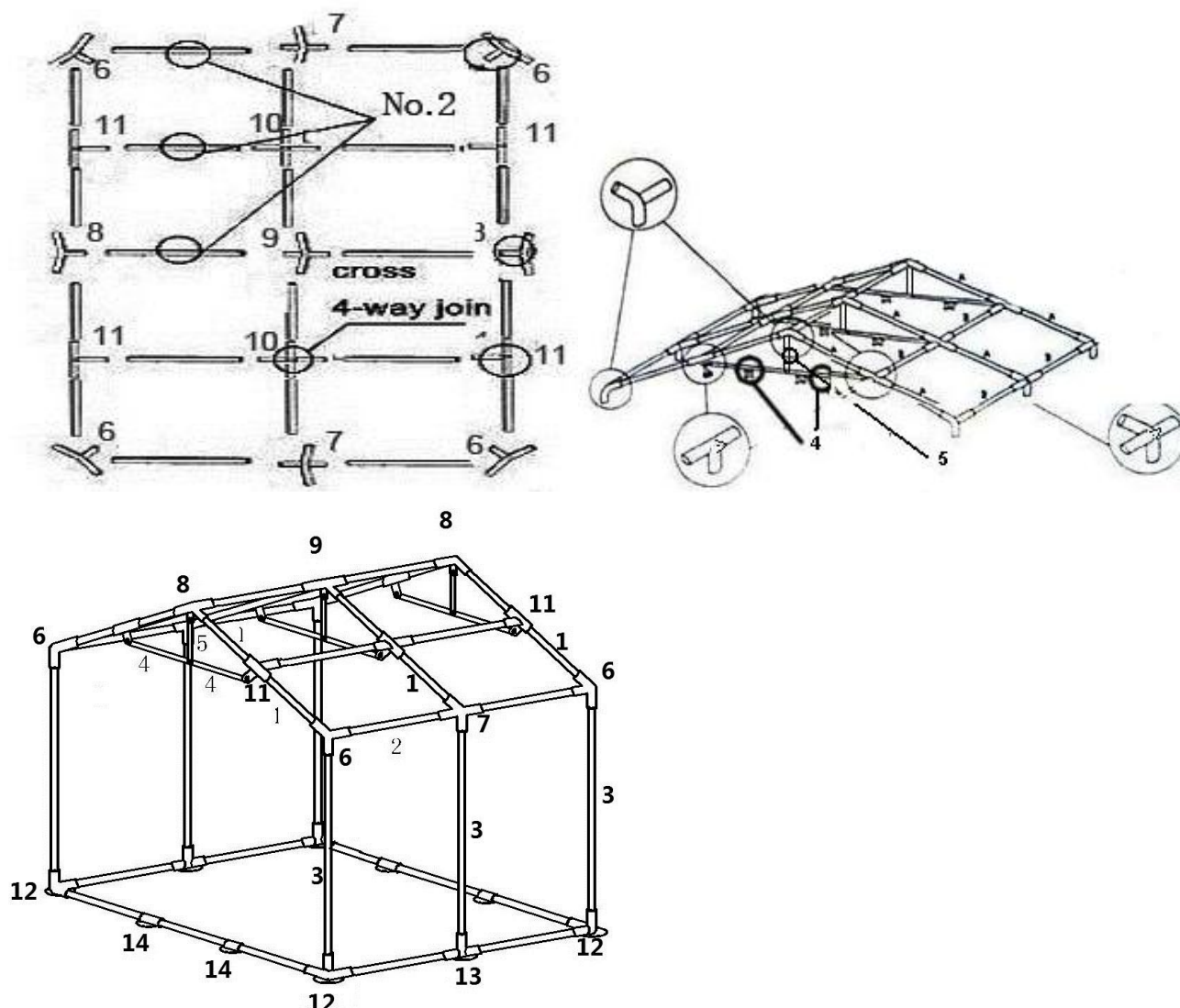

6x 4 PARTY TENT

2. cover the roof on the top frame, like picture shows.

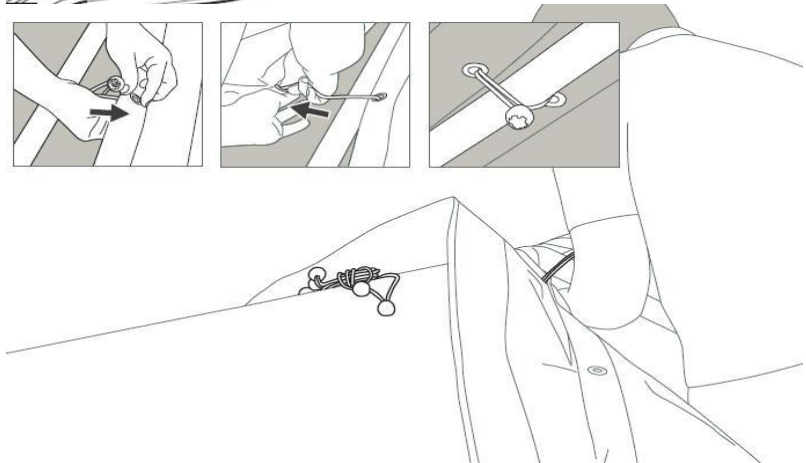
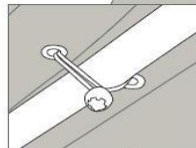
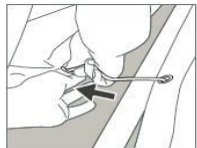
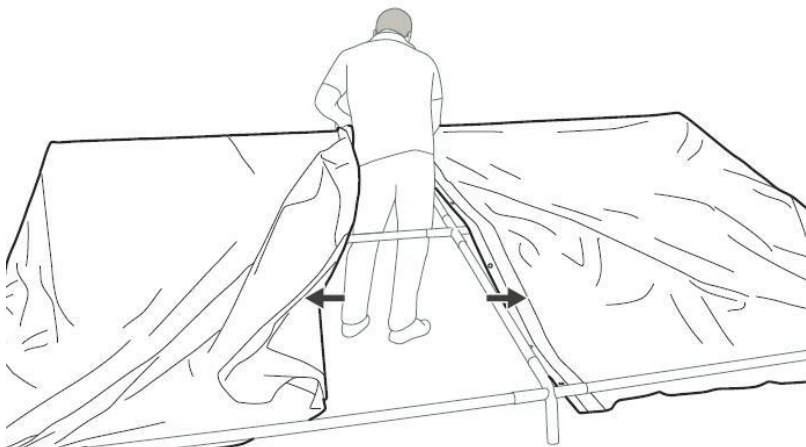
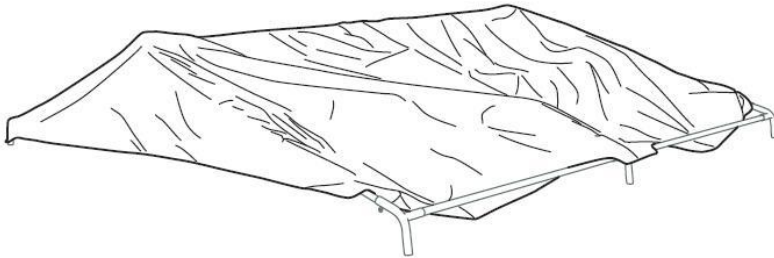
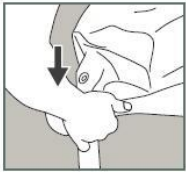
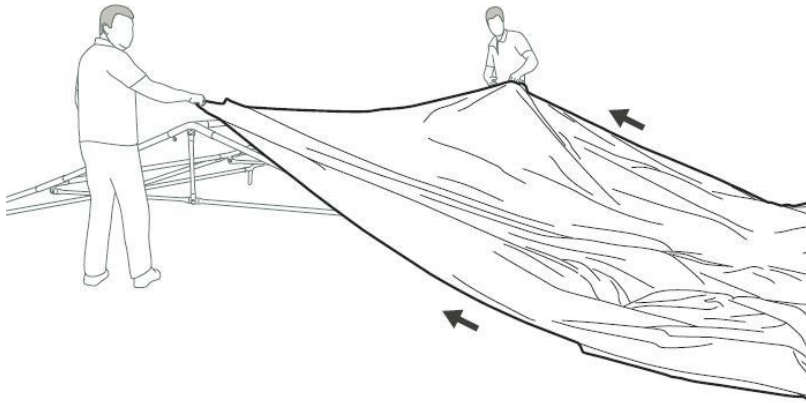

6x 4 PARTY TENT

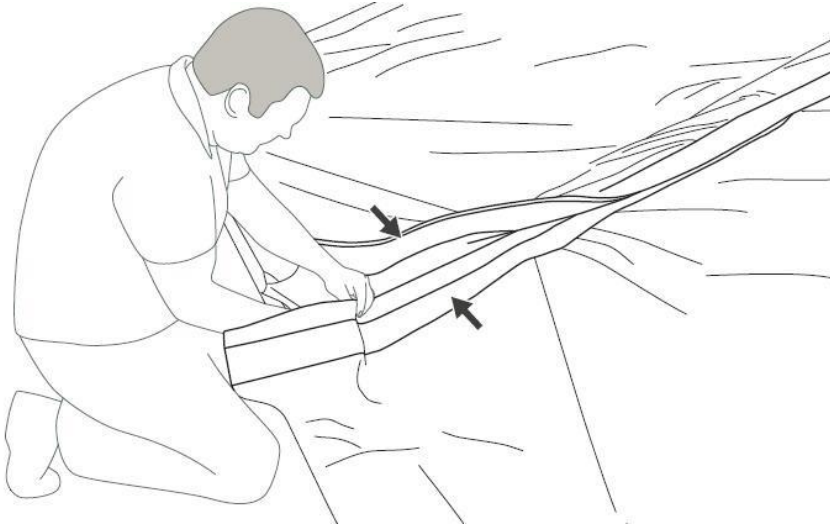

3. Attach one end of the support poles (3) to the roof joints (6,7).

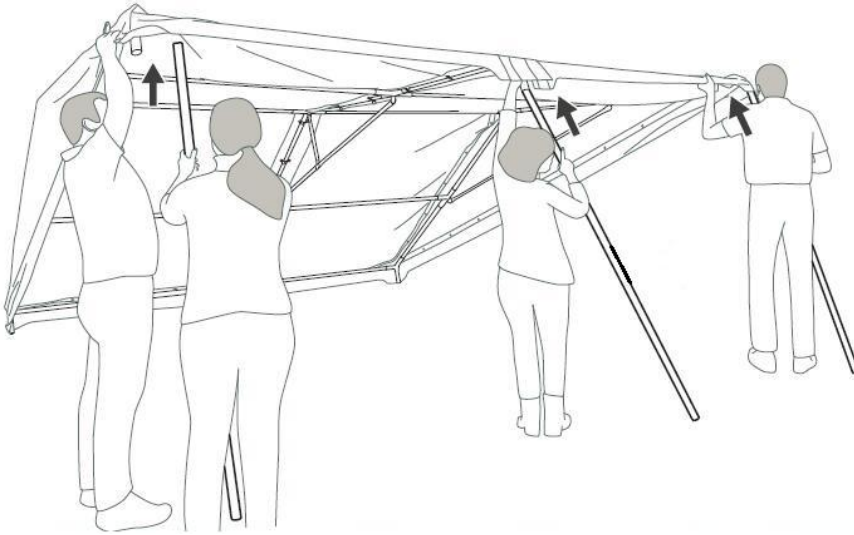

4. Attach the other supporting poles (3) to the joints (6,7), build-up the framework. Use the 6x180mm peg to fix each pole into the ground and use the hook to fix the leg cover to the leg.

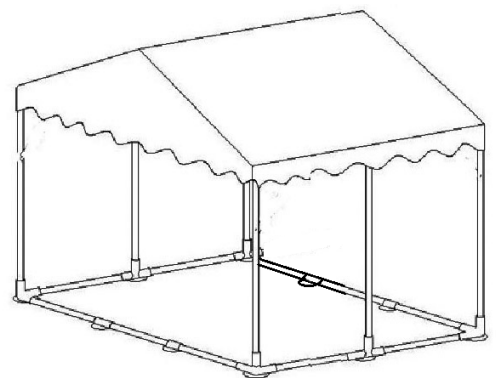

5. Spread the wall and door panels, and attach to framework using the bungee cords. Clasp the frame to the metal eyelets (located over the wall and door panels) to ensure stability. Also use the 4x180mm pegs to fix the doors and walls to the ground.

6x 4 PARTY TENT

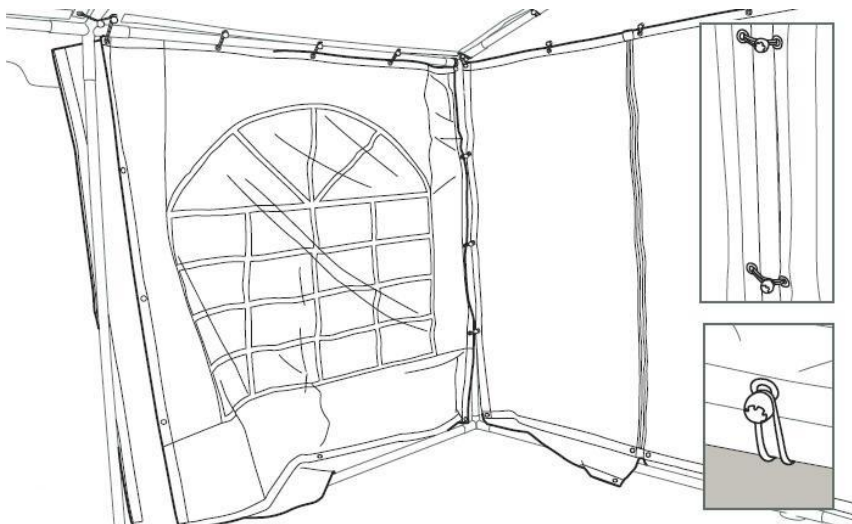
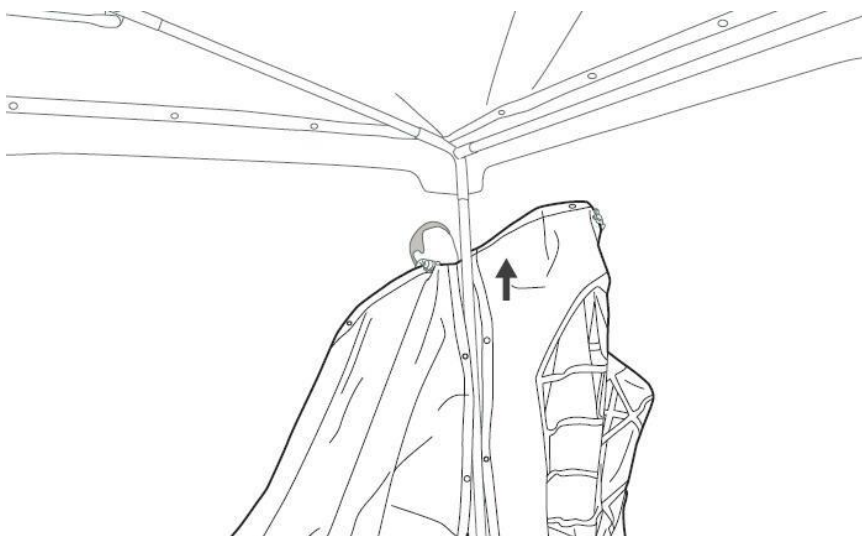
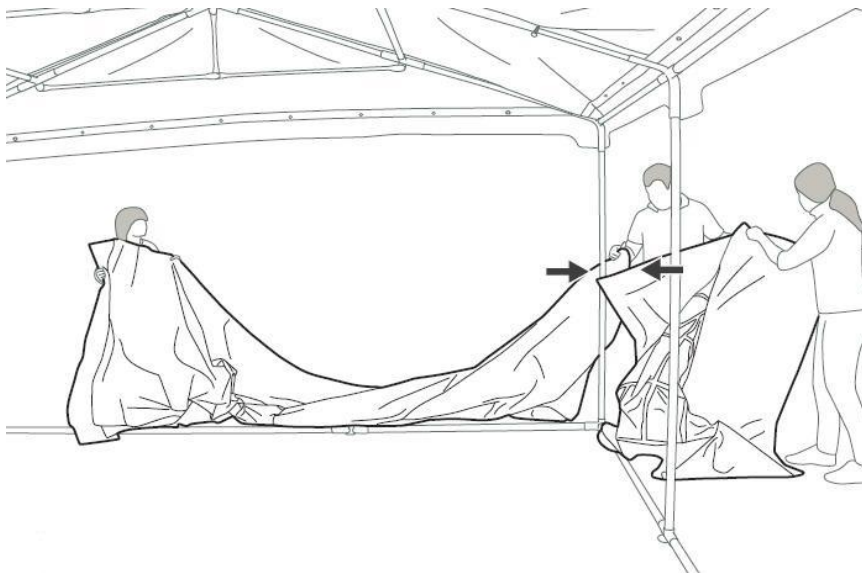

6x 4 PARTY TENT

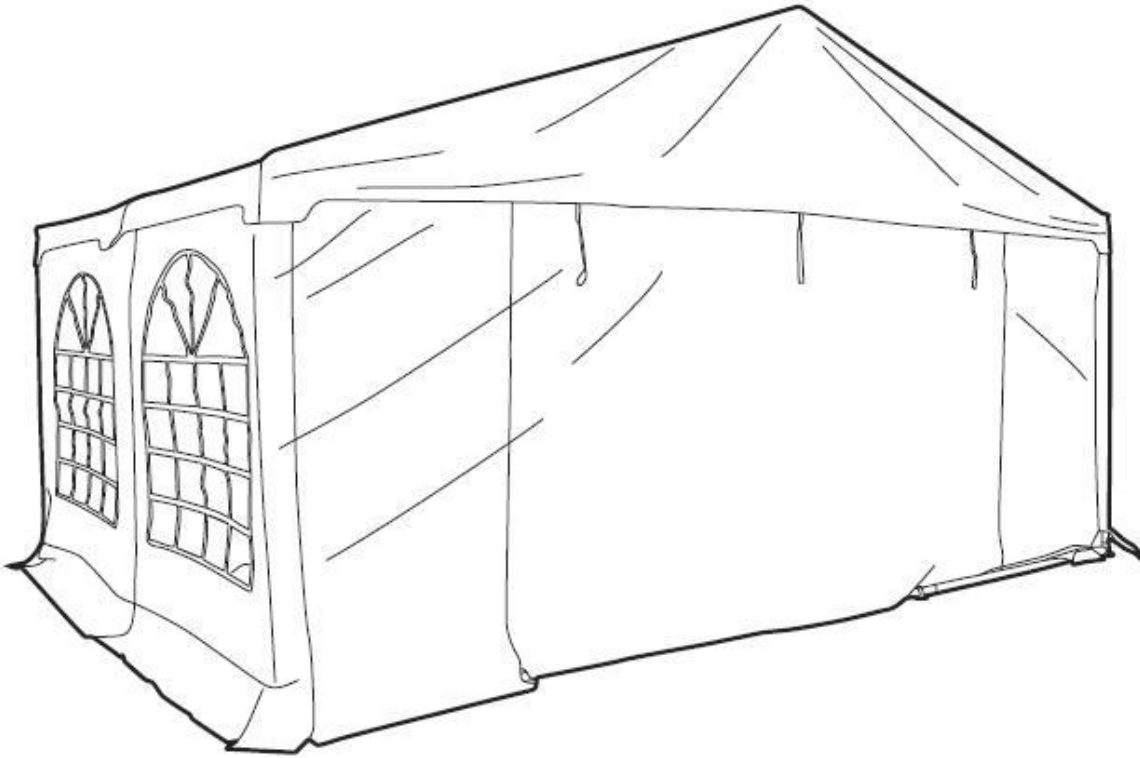

■

VI

Attach Guy line to all corners of tent and fix to ground using spiral peg.

Warning

1. Take note that the tent needs to be handled carefully to avoid damage.
2. Do not force the frame, as there may be damage in the process.
3. Tents are meant as temporary shelter and must be evacuated under extreme weather conditions.
4. Please select a suitable site for the tent to avoid damage to underground sprinkler systems, water, gas or electrical lines.
5. Whilst this product is Fire retardant care should be taken. Keep away from naked flame and other heat sources.

All images used are for illustration purposes only and may not represent an individual product.