

# Owner's Manual & Assembly Instructions

**Item:SG3.3x6**

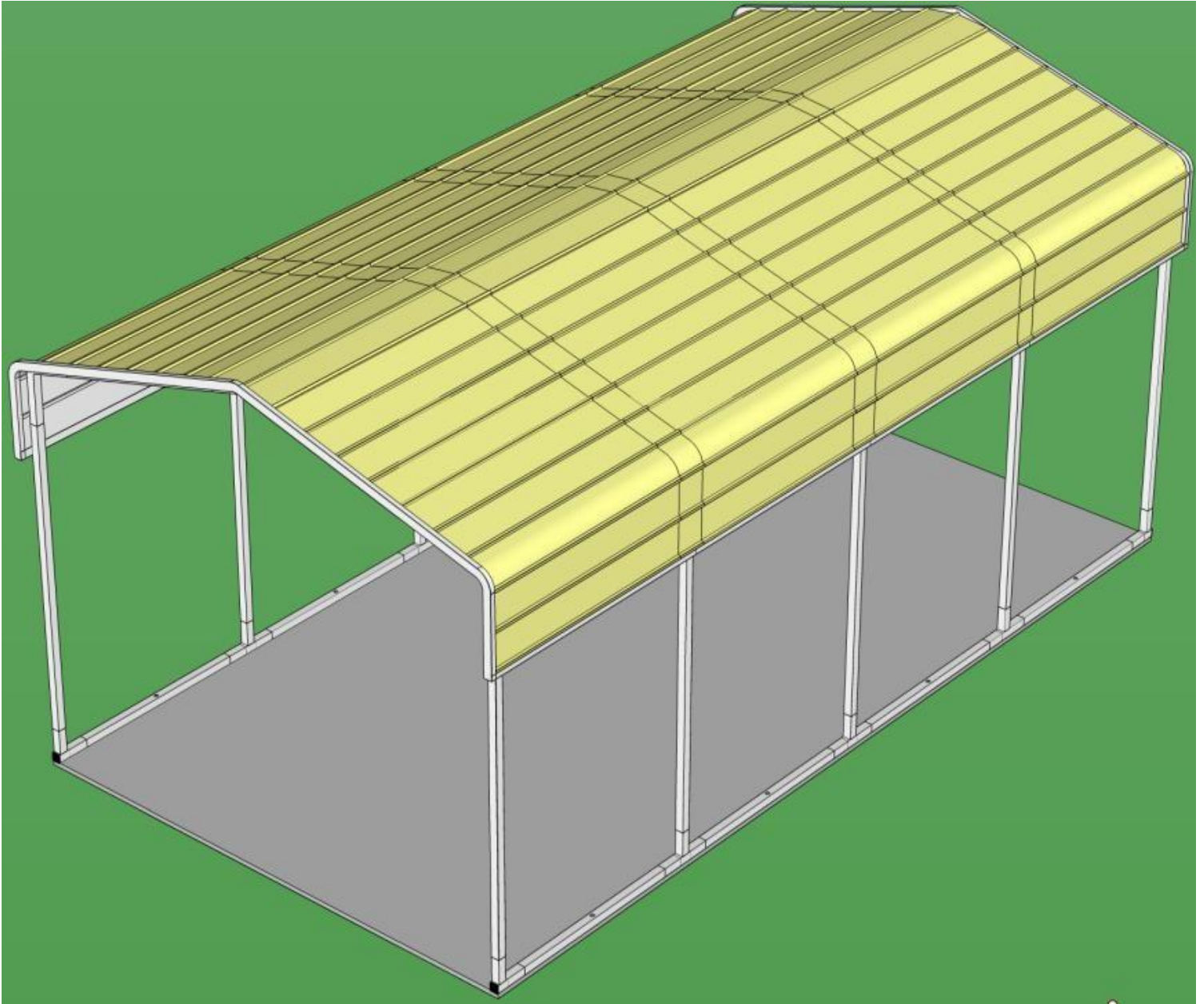

## **BUILDING DIMENSIONS**

### **ITEM:SG3.3X6**

Dimensions:W3.3x D6.0x H2.8 m

Storage Area:19.8m<sup>2</sup> . 51.48m<sup>3</sup> .

Overallsize:W3.5 x D 6.2 m

Recommended Floor:W3.8 x D6.1m

**CAUTION:**SOME PARTS HAVE SHARP EDGES.CARE MUST BE TAKEN WHEN HANDLING THE VARIOUS PIECES TO AVOID A MISHAP.FOR SAFETY SAKE,PLEASE READ SAFETY INFORMATION PROVIDED IN THIS MANUAL BEFORE BEGINNING CONSTRUCTION.WEAR GLOVES WHEN HANDING METAL PARTS.

**IMPORTANT:WEAR HAND GLOVES TO PREVENT INJURY.**

# BEFORE YOU BEGIN

## Owner's Manual:

Before beginning construction, check local building codes regarding footings, location and other requirements. Study and understand this owner's manual. Important information and helpful tips will make your construction easier and more enjoyable.

## Assembly Instructions:

Instructions are supplied in this manual and contain all appropriate information for your building model. Review all instructions before you begin, and during assembly, follow the step sequence carefully for correct results.

## Parts and Parts List:

Check to be sure that you have all the necessary parts, you've your building.

- The first few steps show how to join related parts to make larger sub assemblies which will be used later.

- Familiarize yourself with the hardware and fasteners for easier use during construction.

These are packaged within the carton. Note that extra fasteners have been supplied for your convenience.

## Watch the Weather:

Be sure the day you select to install your building is dry and calm.

Do not attempt to assemble your building on a windy day. Be careful on wet or muddy ground.

## Teamwork:

Whenever possible, two or more people should work together to assemble your building.

One person can position parts or panels while the other is able to handle the fasteners and the tools.

## Tools and Materials:

These are some basic tools and materials you will need for the construction of your building.

Decide which method of anchoring and the type of foundation you wish to use in order to form a complete list of the materials you will need.

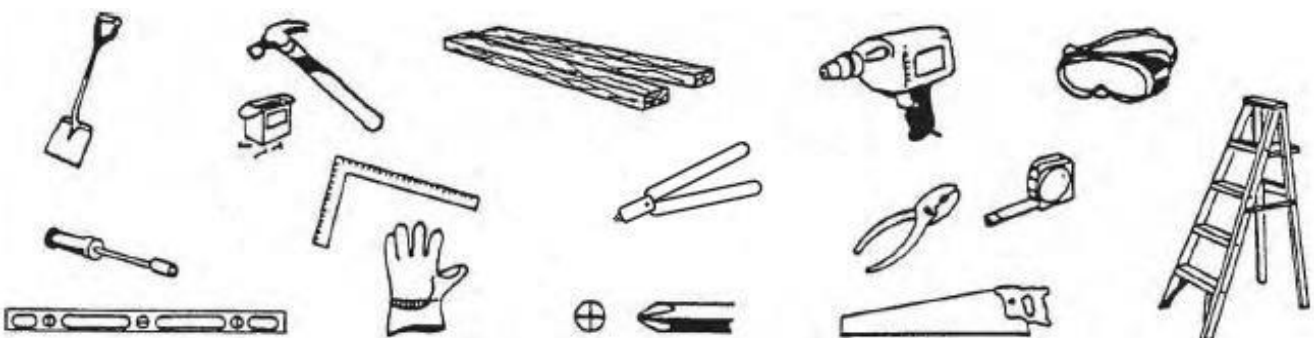

# CARE & MAINTENANCE

**Finish:**For long lasting finish,periodically clean and wax the exterior surface.Touch-up scratches as soon as you notice them on your unit.Immediately clean the area with a wire brush,wash it and apply touch-up paint per manufacturer's recommendation.

**Roof:**Keep roof clear of leaves and snow with long handled,soft-bristled broom.Heavy amounts of snow on roof can damage building making it unsafe to enter.In snow country,Roof Strengthening Kits are available for most TeachYard for added protection against heavy snow accumulation.

**Doors:**Always keep the door tracks clear of dirt and other debris that prevent them from sliding easily.Lubricate door track annually with furniture polish or silicone spray.Keep doors closed and locked to prevent wind damage.

**Fasteners:**Use all washers supplied to protect against weather infiltration and to protect the metal from being scratched by screws.Regularly check your building for loose screws,bolts,nuts,etc.

**Moisture:**A plastic sheet(vapor barrier)placed under the entire floor area with good ventilation will reduce condensation.

## Other Tips...

■ Wash off inked part numbers on coated panels with soap and water.

■ Silicone caulking may be used for watertight seals throughout the building.

**Do not store swimming pool chemicals in your building.Combustibles and corrosives must be stored in air tight approved containers.**

# STEP 1: Building Foundation

**Selecting and Preparing Your Site:**Before assembly,you will want to decide on a location for your building.The best location is a level area with good drainage.

■ Allow enough working space for ease of moving parts into position during assembly.Be sure there will be enough space at entrance for doors to open fully and enough space around the building to be able to fasten the panel screws from the outside.

■ Before you begin the first steps in assembling your parts,a foundation should be constructed should be ready to use.

## Concrete Slab(not included)

The slab should be at least 3" to 4"(8-10cm)thick.It must be level and flat to provide good support for the frame.

The following are the recommended materials for your foundation.

■ 1 x 4's (2.5cm x 10cm)(will be removed once the concrete cures)

■ Concrete ■ Sheet of 6 mil plastic















■ We recommend for a proper strength concrete to use a mix of:  
1 part cement . 3 parts pea sized gravel . 2 1/2 parts clean sand

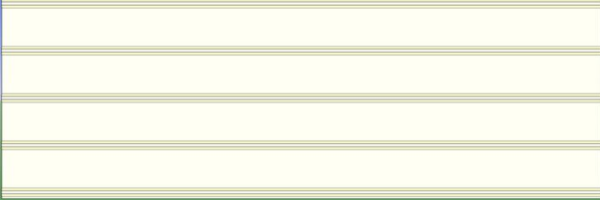

**Of course,you can build on grassland,you don't have to do anything.**

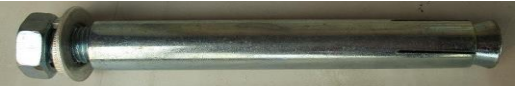
# STEP 2: Checking the Parts

## Parts List

Part No.	Diagram	Length(mm)	QTY(pcs)
A1		210	4
A2		1410	8
A3		350	6
B		2150	10
C		640	10
D		1400	10
E		520	5
P		1680	20
U		2100	6
U1		1625	4
U2		1625	4
S0		φ16x200	8
S1		φ12x25	360
H		50x50	4
G			2

**IMPORTANT:WEAR HAND GLOVES TO PREVENT INJURY.**

# STEP 3: Building the Foundation Kits

## Assembly Show Drawing

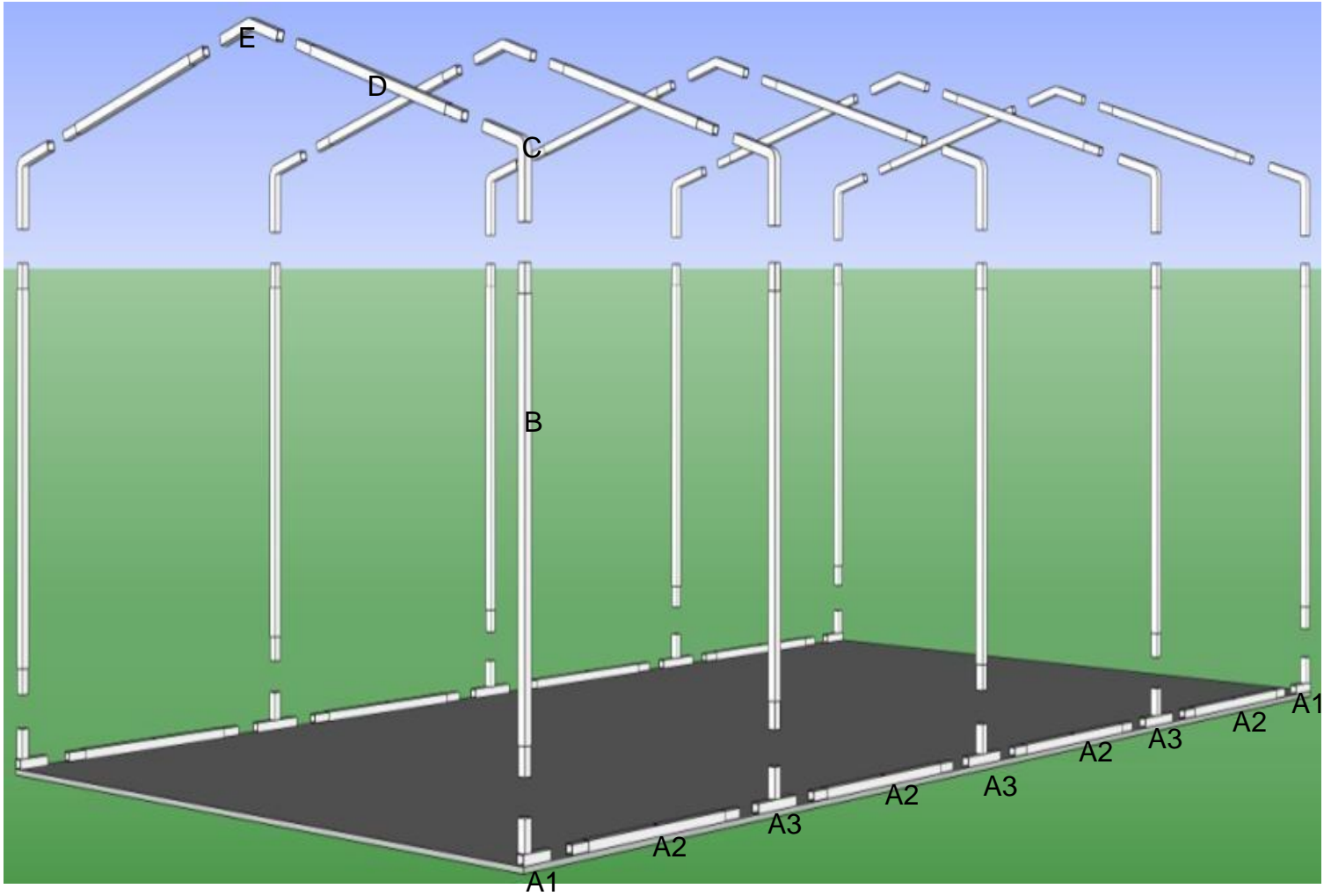

## Assemble the Foundation Kits

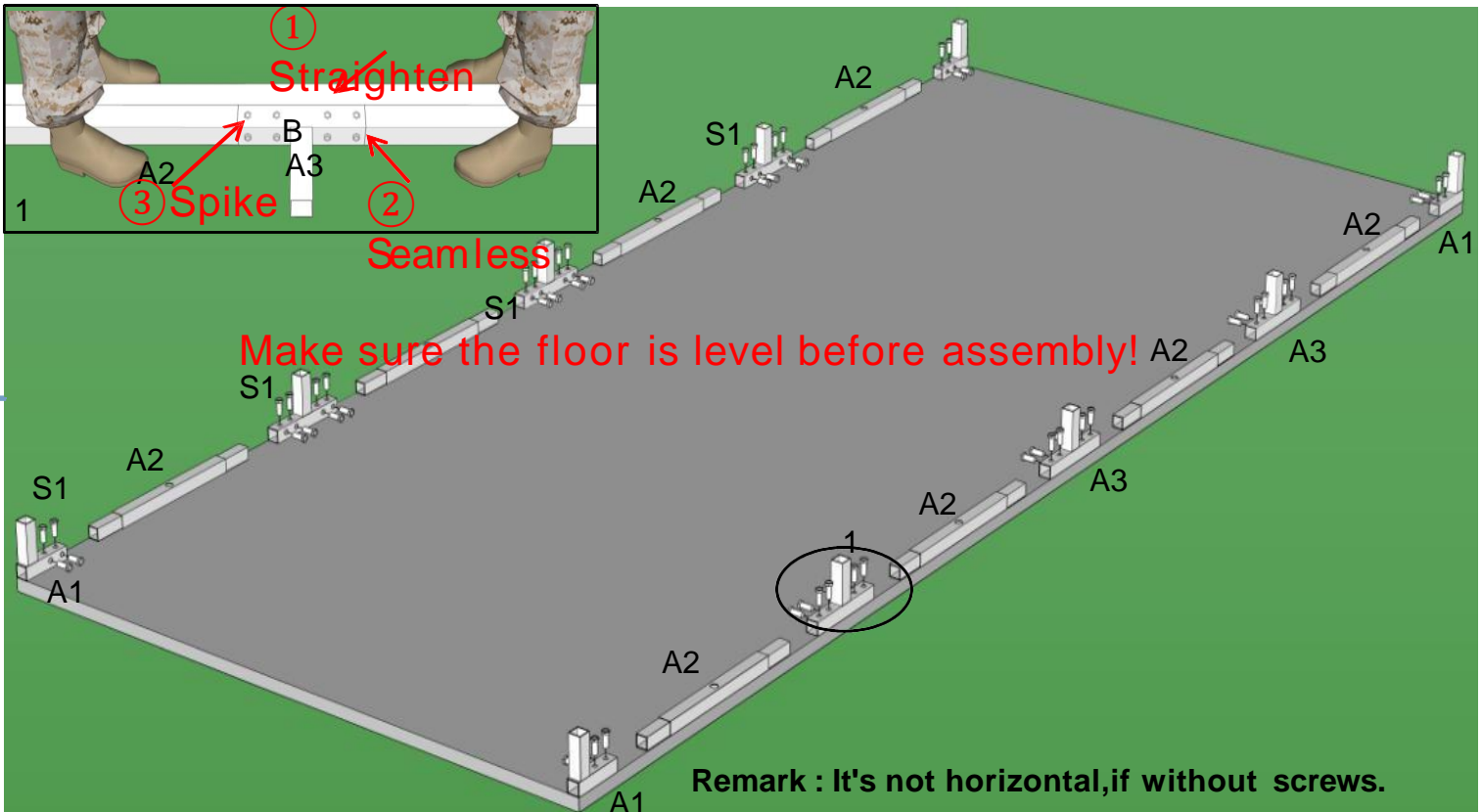

IMPORTANT: WEAR HAND GLOVES TO PREVENT INJURY.



# STEP 4: Building the Side Upstanding

## Assemble the First Upstanding

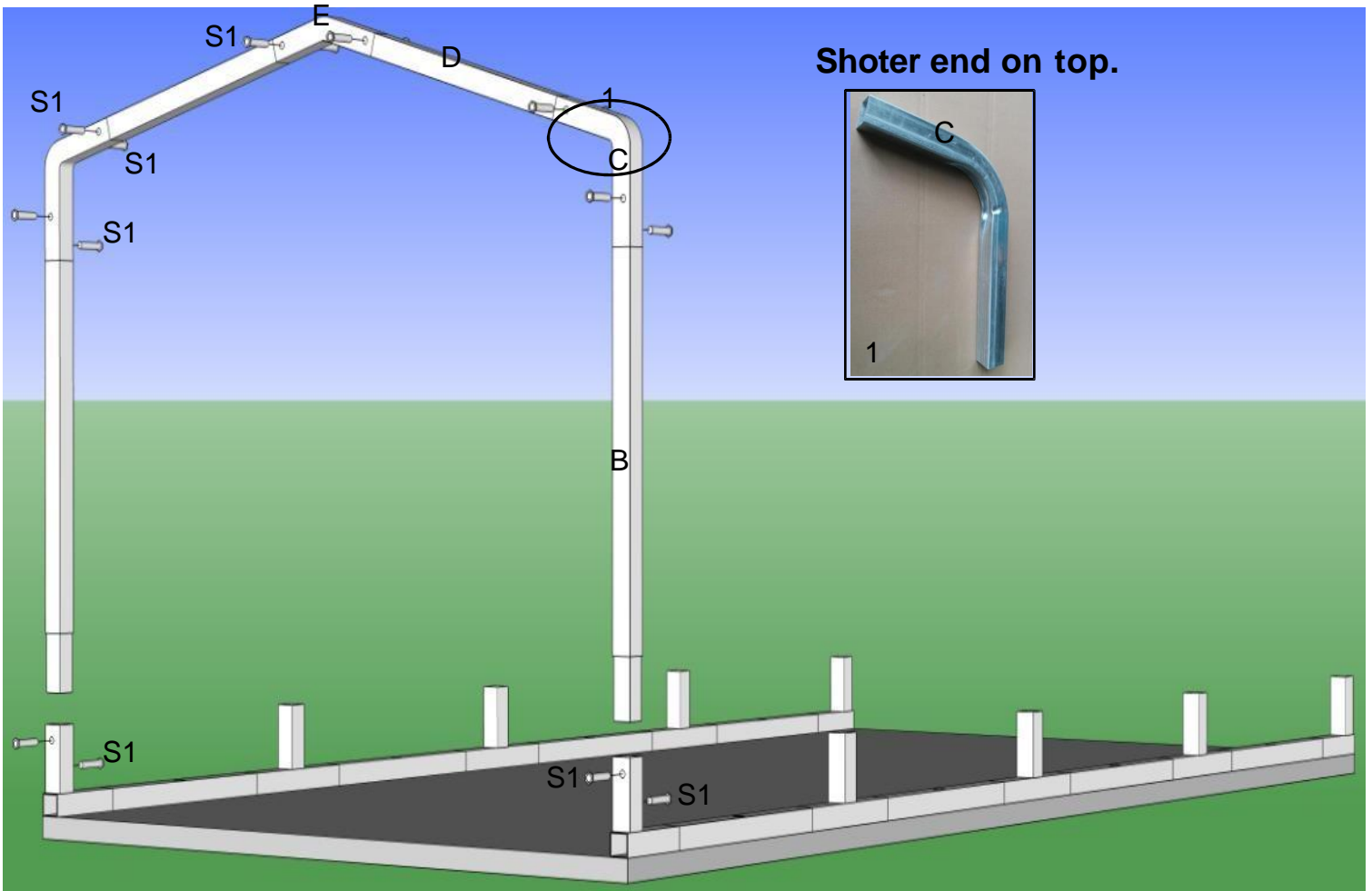

## Assemble the remain 4 set Upstanding and Side Cross-Beams,fix Dynabolts.

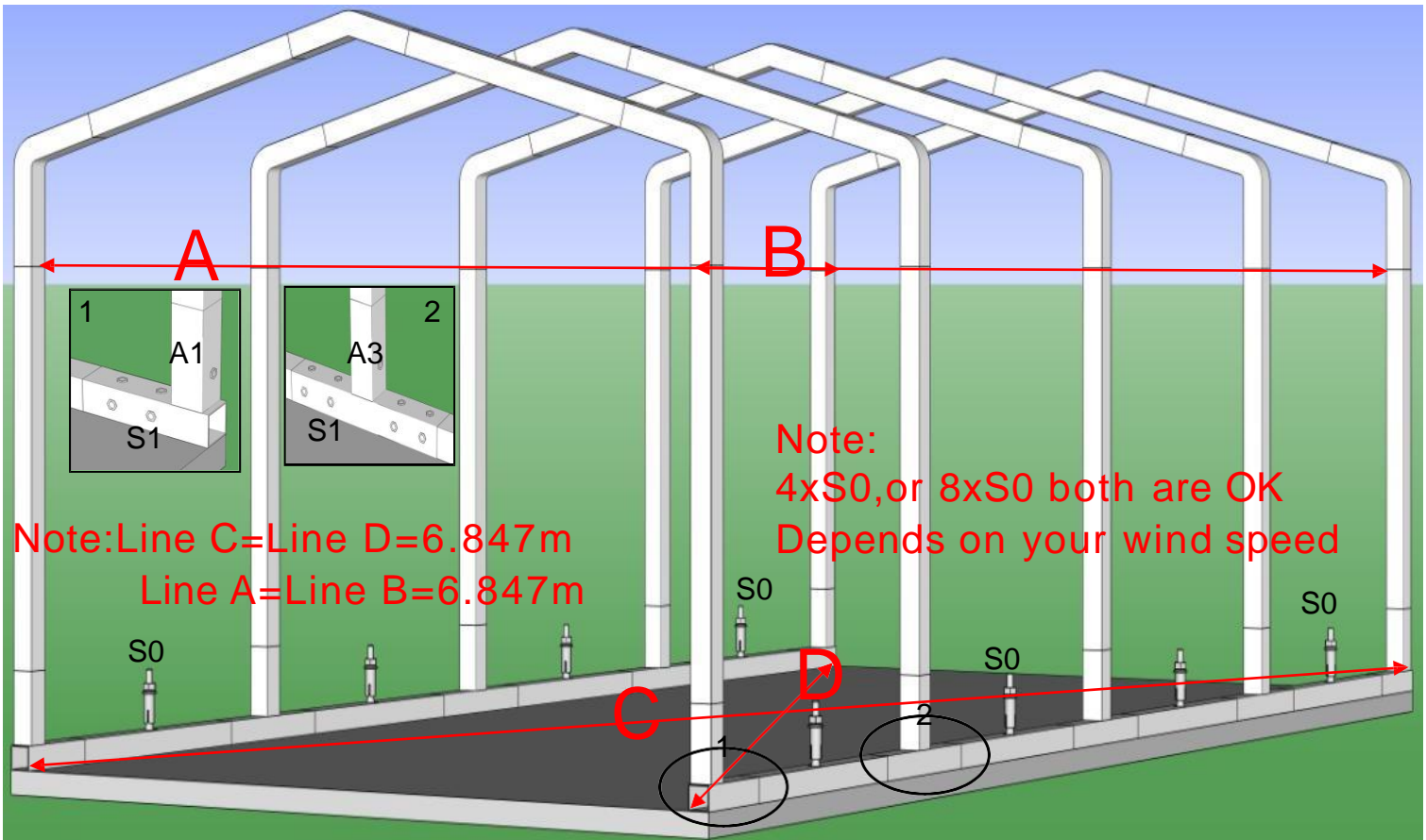

**IMPORTANT:WEAR HAND GLOVES TO PREVENT INJURY.**

# STEP 5: Building the Roof Sheets

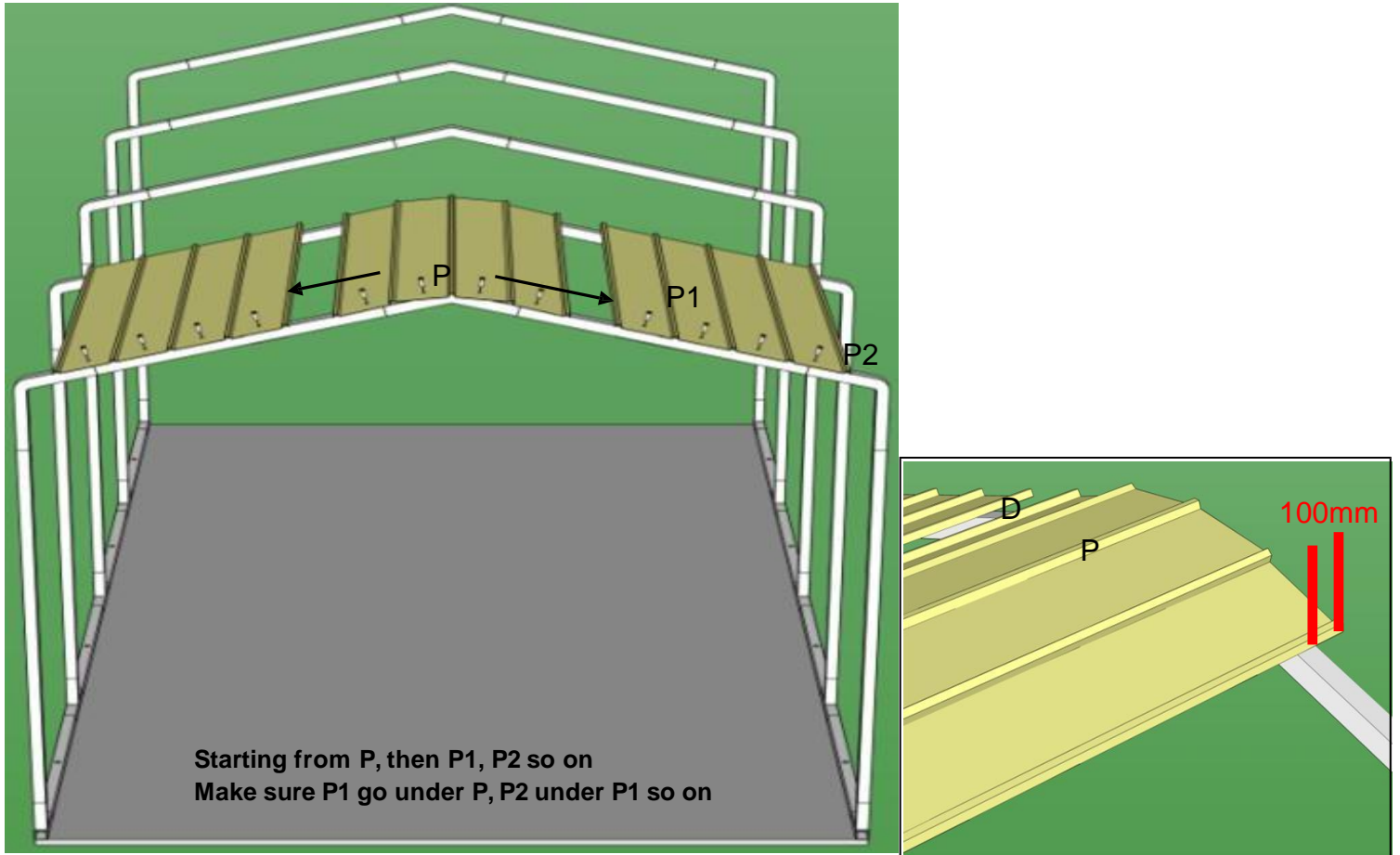

**First, assemble 5 pcs 1680mm sheets**

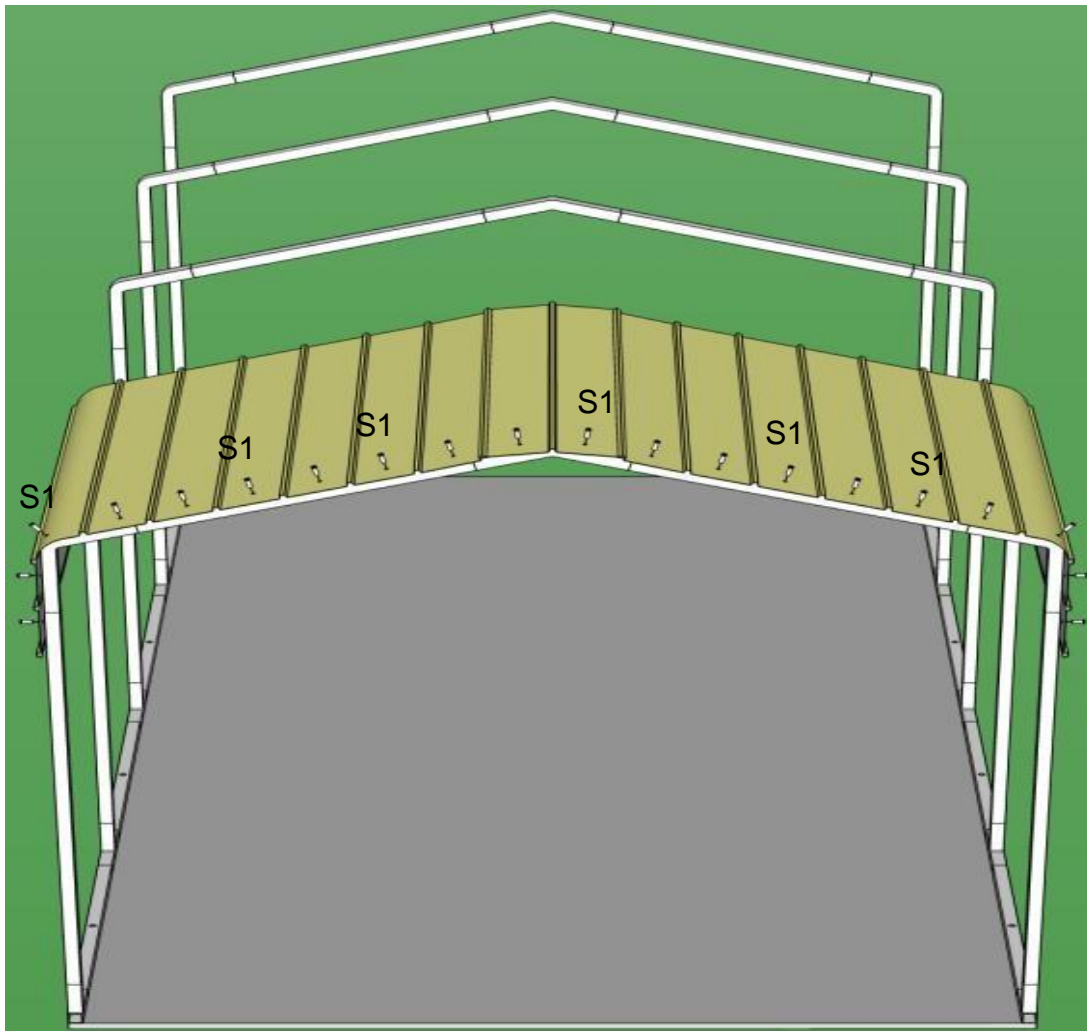

**IMPORTANT: WEAR HAND GLOVES TO PREVENT INJURY.**

# Stick Silicone Sealant on the sheets

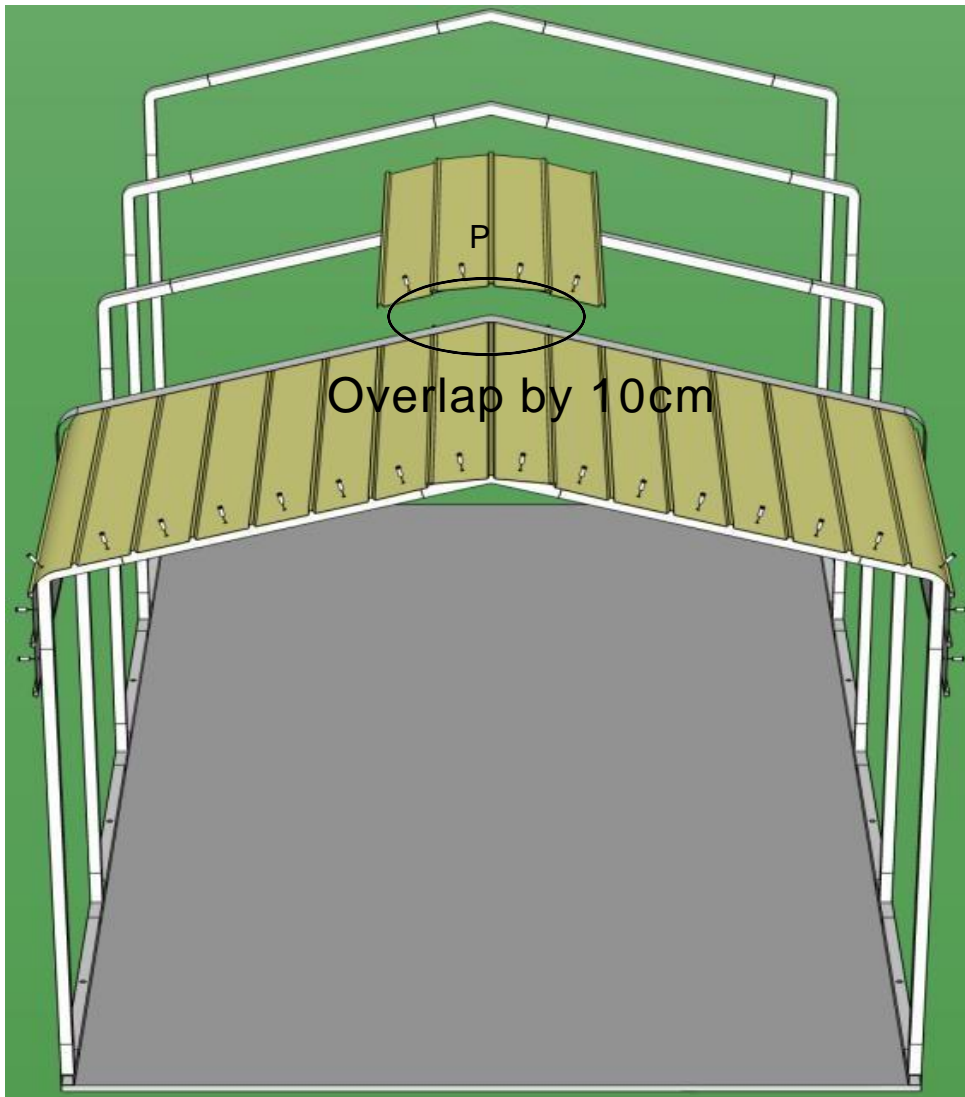

## Step 1: Apply Silicone

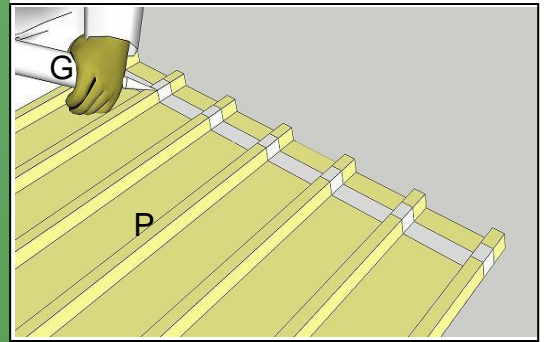

## Step 2: Join the 2 surfaces

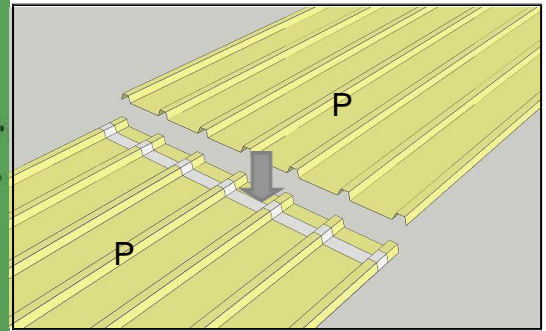

## Step 3: Drill Screws

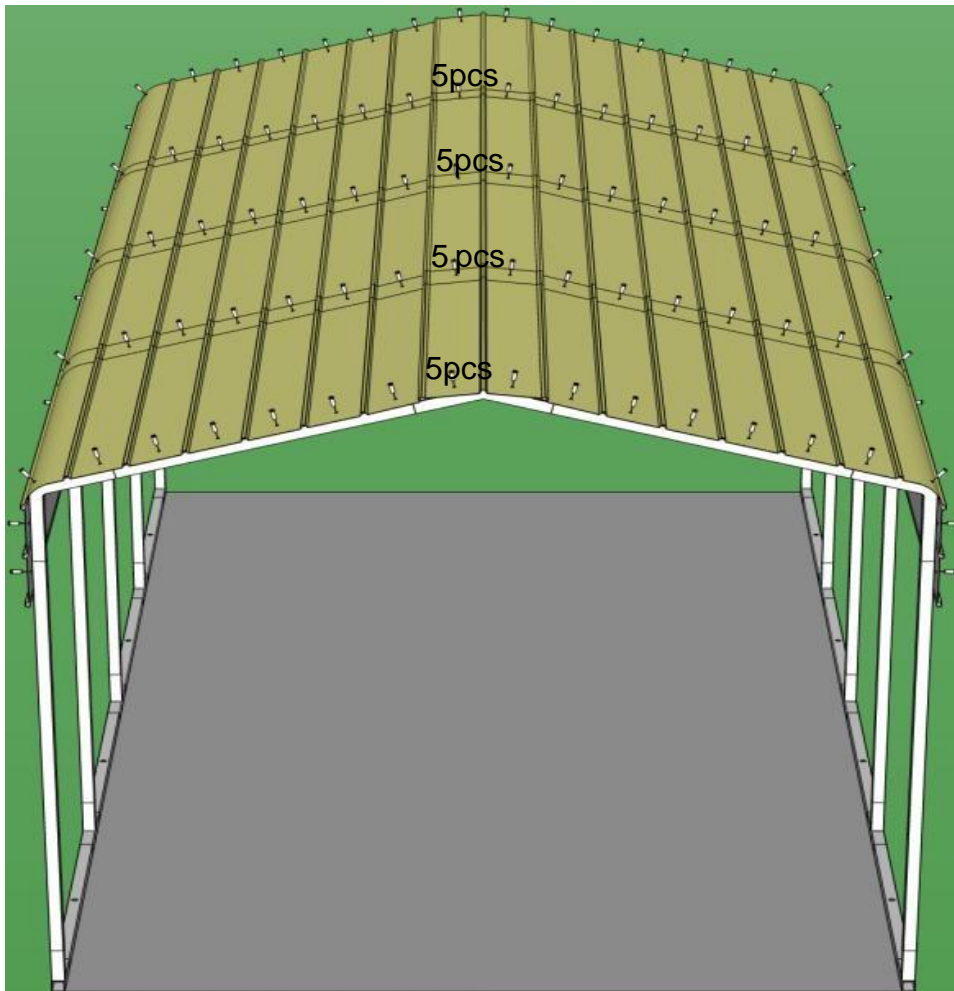
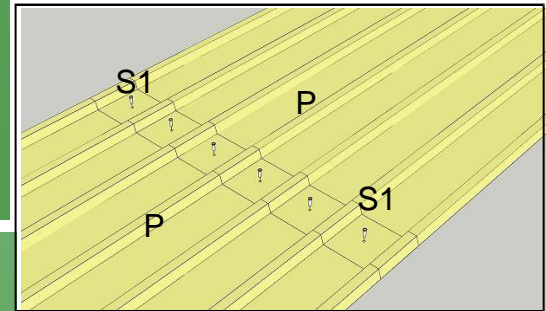

**IMPORTANT: WEAR HAND GLOVES TO PREVENT INJURY.**



# STEP 6: Building the Trim

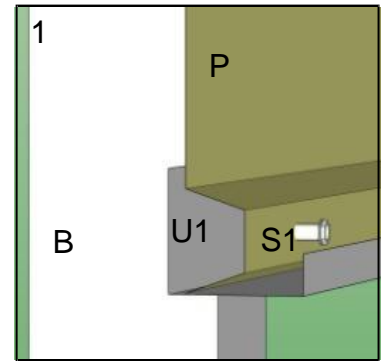
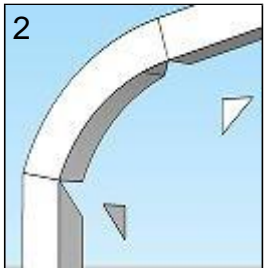
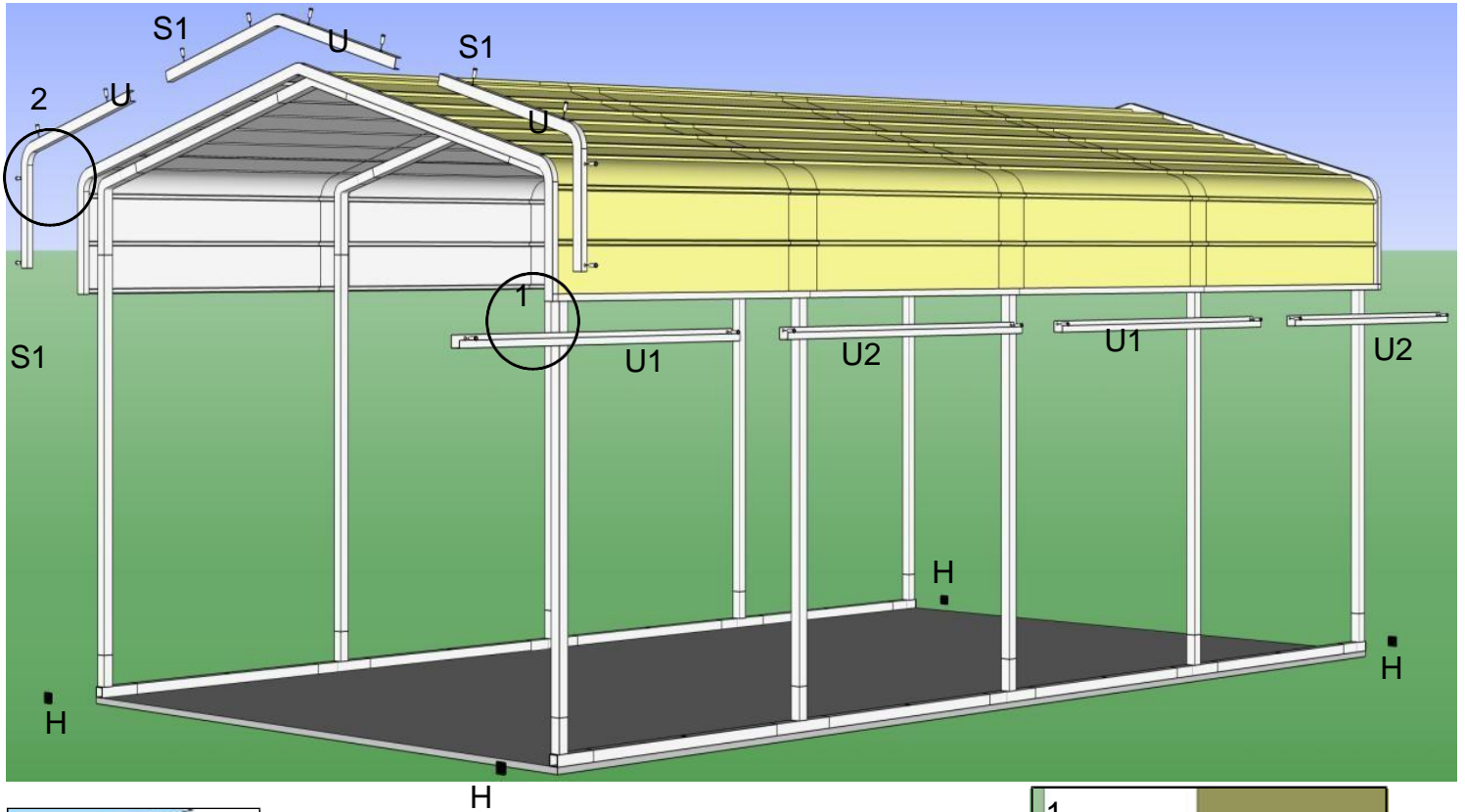

Clean.....

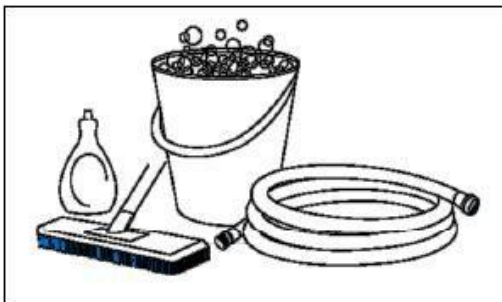

Cut.....

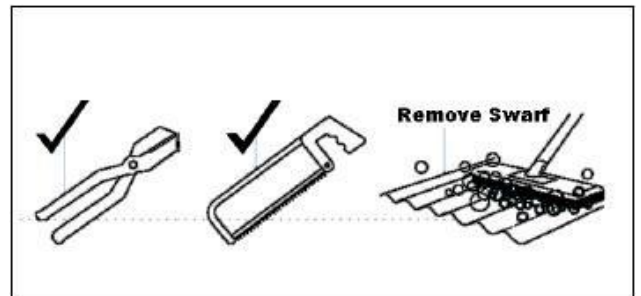

Touch-up paint is not recommended

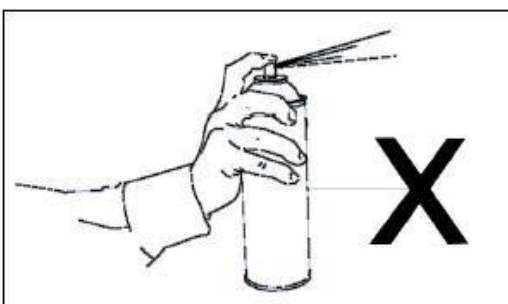

Not recommended

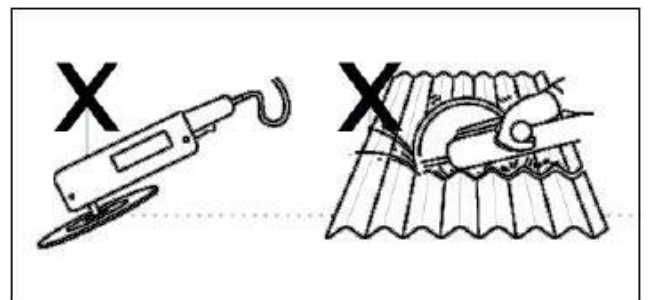

**IMPORTANT: WEAR HAND GLOVES TO PREVENT INJURY.**